

Text in green is to be part of UC Santa Cruz building database and may be part of UCOP database

DATE: 2019-06-28

UC Santa Cruz building seismic ratings
Earth & Marine Sciences
(Office Block A, Lobby, and Atrium Steel Moment Frames)



CAAN #7775.1

552 Red Hill Road, Santa Cruz, CA 95064

UCSC Campus: Main Campus

West Elevation



Plan

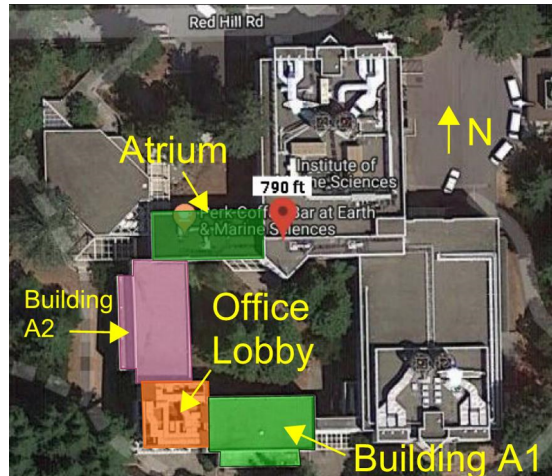

Rating summary	Entry	Notes
UC Seismic Performance Level (rating)	V (Poor)	Pre-Northridge steel connections
Rating basis	Tier 1	ASCE 41-17 ¹
Date of rating	2019	
Recommended UC Santa Cruz priority category for retrofit	Priority B	Priority A=Retrofit ASAP Priority B=Retrofit at next permit application
Ballpark total construction cost to retrofit to IV rating ²	High (\$200-400/sf)	See recommendations on further evaluation and retrofit.
Is 2018-2019 rating required by UCOP?	Yes	1998 Revised Rating was Good (3 checklists, 2 reports)
Further evaluation recommended?	Yes	Tier 3 nonlinear static

¹ We translate this Tier 1 evaluation to a Seismic Performance Level rating using professional judgment. Non-compliant items in the Tier 1 evaluation do not automatically put a building into a particular rating category, but we evaluate such items along with the combination of building features and potential deficiencies, focused on the potential for collapse or serious damage to the gravity supporting structure that may threaten occupant safety. See Section III.B of the 19 May 2017 *UC Seismic Safety Policy* and Method B of Section 321 of the 2016 *California Building Code*.

² Per Section III.A.4.i of the 26 March 2019 *UC Seismic Program Guidebook, Version 1.3*, the cost includes all construction cost necessitated by the seismic retrofit, including restoration of finishes and any triggered work on utilities or accessibility. It does not include soft costs such as design fees or campus costs. The cost is in 2019 dollars.

Building information used in this evaluation

- Architectural drawings by McLellan & Copenhagen, Executive Architects, and Zimmer Gunsul Frasca Partnership, “Earth and Marine Sciences Building, University of California, Santa Cruz,” as-built set dated 16 August 1991, Sheets A0.1 to A8.4.3 (165 sheets). Drawings are for whole complex; relevant sheets for steel moment frames are for “Office Block, Office Lobby, and Atrium.”
- Structural drawings by Rutherford + Chekene, Structural and Civil Engineers, “Earth and Marine Sciences Building, University of California, Santa Cruz,” reference set dated 16 August 1991, Sheets S0.1 to S8.1 (45 sheets). Drawings are for whole complex; relevant sheets for steel moment frames are for “Office Block, Office Lobby, and Atrium.”
- Structural Calculations by Rutherford+ Chekene, three volumes obtained from R+C archive dated February 1990.
- UCSC 1998 Seismic Assessment, two reports by R+C.

Additional building information known to exist

Original Civil, Electrical, Mechanical, Plumbing, Fire Alarm, Honeywell shop drawings not reviewed.

Scope for completing this form

Reviewed architectural and structural drawings for original construction, reviewed original 1990 structural calculations, reviewed 1998 Seismic Assessment, made brief site visit on 3 June 2019, and carried out ASCE 41-17 Tier 1 evaluation.

Brief description of structure

The Earth and Marine Sciences Building is a complex with seven independent structures that include two concrete shear wall laboratory buildings, four steel moment frame office buildings, and one steel braced frame Lecture Hall. The buildings are arranged around a central courtyard on a site that slopes to the south and are typically separated by 2” or 3” seismic gaps. This report addresses the four steel moment framed buildings classified as Model Building Type S1. The moment frame buildings all appear to have 3” gaps between them. These include two office buildings that we are referring to as A1 (South Office) and A2 (North Office), the Office Lobby, and the Atrium that includes two of the levels below grade.

- The two four-story office Buildings A1 and A2 have steel gravity framing and steel moment frames in both directions with exterior precast concrete cladding and metal deck diaphragms with concrete fill. They are both four-story structures that are basically rectangular in plan with few floor openings. As the site slopes down to the south, the north end of Building A2 is below grade, but the floor levels of the office buildings are aligned. The moment frames are located at the perimeter along three sides but set in one bay on the fourth side with reentrant corners. The buildings each have three transverse bays; A1 has 7 longitudinal bays and A2 has eight longitudinal bays. Weights of the two buildings are slightly different.
- The Office Lobby has steel moment frames in both directions with exterior glazing on the south and west sides. The building has an exterior slab on grade at the lowest level and four levels of steel framing. Levels at 1 and 3 only have a small area of flooring for a walkway between the offices and are otherwise open; Level 2 has flooring over roughly half the area; the roof at Level 4 is covered solidly by metal deck and concrete fill. The perimeter bays on the south and west are exterior to the building envelope which consists of full height glazing along those two sides.
- The Atrium consists of a concrete basement level and three levels of steel moment framing. The lowest level of steel framing is below grade, the upper levels are largely open with only a bridge and a ramp connecting the Office A2 to Lab Block C. The steel framing supports full height glazing along both the north, south, and west walls.
- Steel framed bridges connect Office A1 and Lab Block D at each level. These bridges are detailed on the steel drawings but are anchored to the wall at Lab Block D with a slip joint at the interface with Office A1. The south edge of these bridges also has a steel structure that supports full height glazing.

Building Condition: The building appeared to be well maintained for a structure of this vintage. We did not observe any signs of structural deterioration that would influence the rating. We did observe that portions of

the Lobby, bridges, and auxiliary frames with exposed framing have weathered paint; these painted surfaces should be maintained to prevent future deterioration.

Identification of levels: The site slopes down from the north to the south, and some portions of the complex are below grade. Structurally, each of the moment frame buildings was designed as a four-story structure. The Office Buildings A1 and A2 are both structurally four-story buildings, but the north end of A1 is partially below grade. These office buildings are basically rectangular in plan and oriented at 90 degrees to each other, joined by the Office Lobby structure. The Office Lobby at the southwest corner is rectangular in plan and four stories above grade. The Lobby roof has steel deck with concrete fill but many of the floor areas at lower levels include large open areas, balconies, or exposed steel framing without any floor surface. The Atrium is a rectangular four-story structure with two above grade and two below grade levels. The lowest level is entirely concrete; the steel moment frame has three levels. The Atrium structure has framing at two floor levels above grade, but the levels are largely open with only a bridge and a ramp connecting Building A2 to Lab Block C.

Foundation system: The A1, A2 and Lobby buildings have continuous grade beams, typically 36" wide by 36" deep, along the lines of moment framing. Gravity columns are founded on individual spread footings at the interior and spread footings with tie beams at the perimeters. Footings at the Atrium include a wall footing along the north side below grade, two interior spread footings that support moment frame columns, and spread footings with tie beams along the east, west, and south sides.

Structural system for vertical (gravity) load: The buildings all have steel gravity framing consisting of metal deck with concrete fill spanning to WF beams, girders, and columns. The roof levels at Buildings A1 and A2 have 2-1/4" of insulating concrete fill; the Atrium, Lobby roofs and all office floor levels have normal weight concrete fill.

Structural system for lateral forces: The buildings all have steel moment frames designed per the 1988 UBC using an allowable stress design base shear of $V=0.183W$ and an R_w value of 12. Each structure has two moment frames in each direction. The Buildings A1 and A2 moment frames have three transverse bays and seven or eight longitudinal bays. These are perimeter frames on three sides and inset by one bay on the fourth side. The Lobby building moment frames have three bays along the edges adjoining the office wings and two bays along the other two sides. The Atrium has perimeter frames with largely exposed framing at the upper levels that supports exterior glazing and only small areas of flooring that provide a bridge and ramp between the office and lab buildings. The Atrium building is a four-story structure but only three levels of steel moment framing.

As cited in the UCSC 1998 Seismic Survey, these moment frames were designed and built prior to the 1994 Northridge Earthquake and feature non-ductile detailing at the beam-to-column connections. Typical connections use complete joint penetration (CJP) welded beam flanges and bolted beam webs. However, the exposed moment frames at the Lobby and Atrium feature CJP welded beam flanges and beam webs, presumably for aesthetic reasons.

Brief description of seismic deficiencies and expected seismic performance including mechanism of nonlinear response and structural behavior modes

Identified seismic deficiencies of the building include the following:

- Drifts checked using the Quick Check procedure exceed the drift limits for the lower two floors of Buildings A1 and A2.
- These buildings all have Pre-Northridge connections with full-penetration flange welds and are considered noncompliant for this Tier 1 evaluation. The beam-to-column connections do not have the capacity to develop the strength of the beams.
- Current strong column-weak beam provisions are not met at any of the representative locations checked in Buildings A1 and A2. The relative strengths of the beams and columns do meet the 1988 UBC requirements for strong column-weak beam provisions, but current formulations in AISC 341-10 are more conservative, using a general 1.1 multiplier and an R_y expected strength multiplier for beams. Neither of these were required in the 1988 UBC.
- Seismic gaps provided between the adjoining moment frame buildings appear to be 3" from the original drawings. The check for gaps between adjacent buildings would require gaps of over 9" ($52' \cdot 12'' \cdot 0.015 = 9.36''$).

Although the floor levels align, pounding between the wings may result in localized damage, particularly where the office egress is through the adjoining Lobby structure.

- The Lobby and Atrium have large areas with exposed framing and without floor diaphragms to provide out-of-plane bracing and to deliver loads. These buildings may not be well suited for the Quick Check procedures.

The expected seismic performance includes the following:

- Large interstory drifts may lead to both structural and nonstructural damage.
- The Lobby and Atrium structures support large glazing panels above exits and if pounding occurs because of insufficient gap between buildings, the glazing may shatter and fall representing a life safety hazard at these exits.
- Welds at the beam-to-column connections may withstand only a few cycles of inelasticity generated by the design earthquake before they fracture. That has been the behavior observed experimentally with this type of connection. Connections where both the beam flanges and the beam web feature CJP welds are expected to perform better than those featuring a bolted web.
- Where moment frame beams are not adequately braced, the limit state of lateral torsional buckling may prevail over yielding of the beam ends and that may protect the beam-to-column connection. However, such a limit state does not dissipate as much energy as anticipated for a moment frame system.
- Where moment frame columns are not stronger than moment frame beams, plastic hinges may form in the column potentially leading to an undesirable story mechanism.

Structural deficiency	Affects rating?	Structural deficiency	Affects rating?
Lateral system stress check (wall shear, column shear or flexure, or brace axial as applicable)	N	Openings at shear walls (concrete or masonry)	N
Load path	N	Liquefaction	N
Adjacent buildings	Y	Slope failure	N
Weak story	N	Surface fault rupture	N
Soft story	N	Masonry or concrete wall anchorage at flexible diaphragm	N
Geometry (vertical irregularities)	N	URM wall height-to-thickness ratio	N
Torsion	N	URM parapets or cornices	N
Mass – vertical irregularity	N	URM chimney	N
Cripple walls	N	Heavy partitions braced by ceilings	N
Wood sills (bolting)	N	Appendages	N
Diaphragm continuity	Y		

Summary of review of nonstructural life-safety concerns, including at exit routes.³

The Lobby, Atrium, and bridge from the Office to Lab buildings have full height glazing supported by flexible moment frames and situated with inadequate seismic gaps to the adjacent wings. Pounding between the four adjacent moment frames may result in damage to the glazing resulting in life safety falling hazards at the Lobby and Atrium exits.

³ For these Tier 1 evaluations, we do not visit all spaces of the building; we rely on campus staff to report to us their understanding of if and where nonstructural hazards may occur.

UCOP nonstructural checklist item	Life safety hazard?	UCOP nonstructural checklist item	Life safety hazard?
Heavy ceilings, feature or ornamentation above large lecture halls, auditoriums, lobbies or other areas where large numbers of people congregate	Yes	Unrestrained hazardous materials storage	None observed
Heavy masonry or stone veneer above exit ways and public access areas	None observed	Masonry chimneys	None observed
Unbraced masonry parapets, cornices or other ornamentation above exit ways and public access areas	None observed	Unrestrained natural gas-fueled equipment such as water heaters, boilers, emergency generators, etc.	None observed

Basis of rating

A Seismic Performance Level rating of V is assigned to these buildings because of the deficiencies identified by the Tier 1 check. The steel moment frame details are not as ductile as required, with similar connections exhibiting poor seismic performance in laboratory tests. The strong-column-weak-beam deficiency may lead to potential formation of flexural hinges in frame columns. In addition, the Tier 1 analyses indicated some frames do not meet drift requirements, and seismic separations between buildings are insufficient.

Recommendations for further evaluation or retrofit

We recommend performing a Tier 3 evaluation to obtain a more refined quantification of frame shears and interstory drifts. We recommend that nonlinear analyses be performed to better quantify the flexural demands and capacities at the beam-column connections. Nonlinear analyses will also contribute to better understand the magnitude of the issues with the flexural strength of the frame columns and the potential for a story mechanism.

Peer review of rating

This seismic evaluation was discussed in a peer review meeting on 24 June 2019. Reviewers present were Joe Maffei of Maffei Structural Engineering and Jay Yin of Degenkolb Engineers. Comments from the reviewers have been incorporated into this report. The reviewers agreed with the assigned rating.

Additional building data	Entry	Notes
Latitude	36.997938	
Longitude	-122.059722	
Are there other structures besides this one under the same CAAN#	Yes	
Number of stories above lowest perimeter grade	4	Typical for A1, A2 and Lobby. Atrium has 2 above grade
Number of stories (basements) below lowest perimeter grade	0	Atrium has 2 levels below grade
Building occupiable area (OGSF)	43,058	Computed as total minus B, C, D and Atrium Level 1 (Total from UCSC Database for #7775 is 152,080).
Risk Category per 2016 CBC Table 1604.5	II	
Building structural height, h_n	52 ft	Structural height defined per ASCE 7-16 Section 11.2
Coefficient for period, C_t	0.035	Estimated using ASCE 41-17 equation 4-4 and 7-18
Coefficient for period, β	0.80	Estimated using ASCE 41-17 equation 4-4 and 7-18
Estimated fundamental period	0.83 sec	Estimated using ASCE 41-17 equation 4-4 and 7-18
Site data		
975-year hazard parameters S_s, S_1	1.283, 0.487	From OSHPD/SEAOC website

Site class	D	
Site class basis	Geotech ⁴	See footnote below
Site parameters F_a, F_v	1.0, 1.813	From OSHPD/SEAOC website
Ground motion parameters S_{cs}, S_{c1}	1.283, 0.882	From OSHPD/SEAOC website
S_a at building period	1.07	
Site V_{s30}	900 ft/s	
V_{s30} basis	Estimated	Estimated based on site classification of D.
Liquefaction potential	Low	
Liquefaction assessment basis	County map	See footnote 4 above
Landslide potential	Low	
Landslide assessment basis	County map	See footnote 4 above
Active fault rupture identified at site	No	
Fault rupture assessment basis	County map	See footnote 4 above
Site-specific ground motion study?	No	
Applicable code		
Applicable code or approx. date of original construction	Built: 1993 Code: 1988 UBC	
Applicable code for partial retrofit	None	No partial retrofit.
Applicable code for full retrofit	None	No full retrofit
FEMA P-154 data		
Model building type – north-south	S1 Steel Moment Frame	
Model building type – east-west	S1 Steel Moment Frame	
FEMA P-154 score	N/A	Not included here because we performed ASCE 41 Tier 1 evaluation.
Previous ratings		
Most recent rating	Good	UCSC 1998 Seismic Survey #7775.
Date of most recent rating	1998	

⁴ Determination of site class and assessment of geotechnical hazards are based on correspondence with Pacific Crest Geotechnical Engineers and Nolan, Zinn, and Associates Geologists. [Revised Geology and Geologic Hazards, Santa Cruz Campus, University of California, Job # 04003-SC 13 May 2005]. Site class is taken as D throughout the main campus of UC Santa Cruz. The following links provide hazard maps for liquefaction, landslide, and fault rupture:
<https://gis.santacruzcounty.us/mapgallery/Emergency%20Management/Hazard%20Mitigation/LiquifactionMap2009.pdf>
<https://gis.santacruzcounty.us/mapgallery/Emergency%20Management/Hazard%20Mitigation/LandslideMap2009.pdf>
<https://gis.santacruzcounty.us/mapgallery/Emergency%20Management/Hazard%20Mitigation/FaultZoneMap2009.pdf>

2 nd most recent rating	-	
Date of 2 nd most recent rating	-	
3 rd most recent rating	-	
Date of 3 rd most recent rating	-	
Appendices		
ASCE 41 Tier 1 checklist included here?	Yes	Refer to attached checklist file.

Site Plan for Orientation

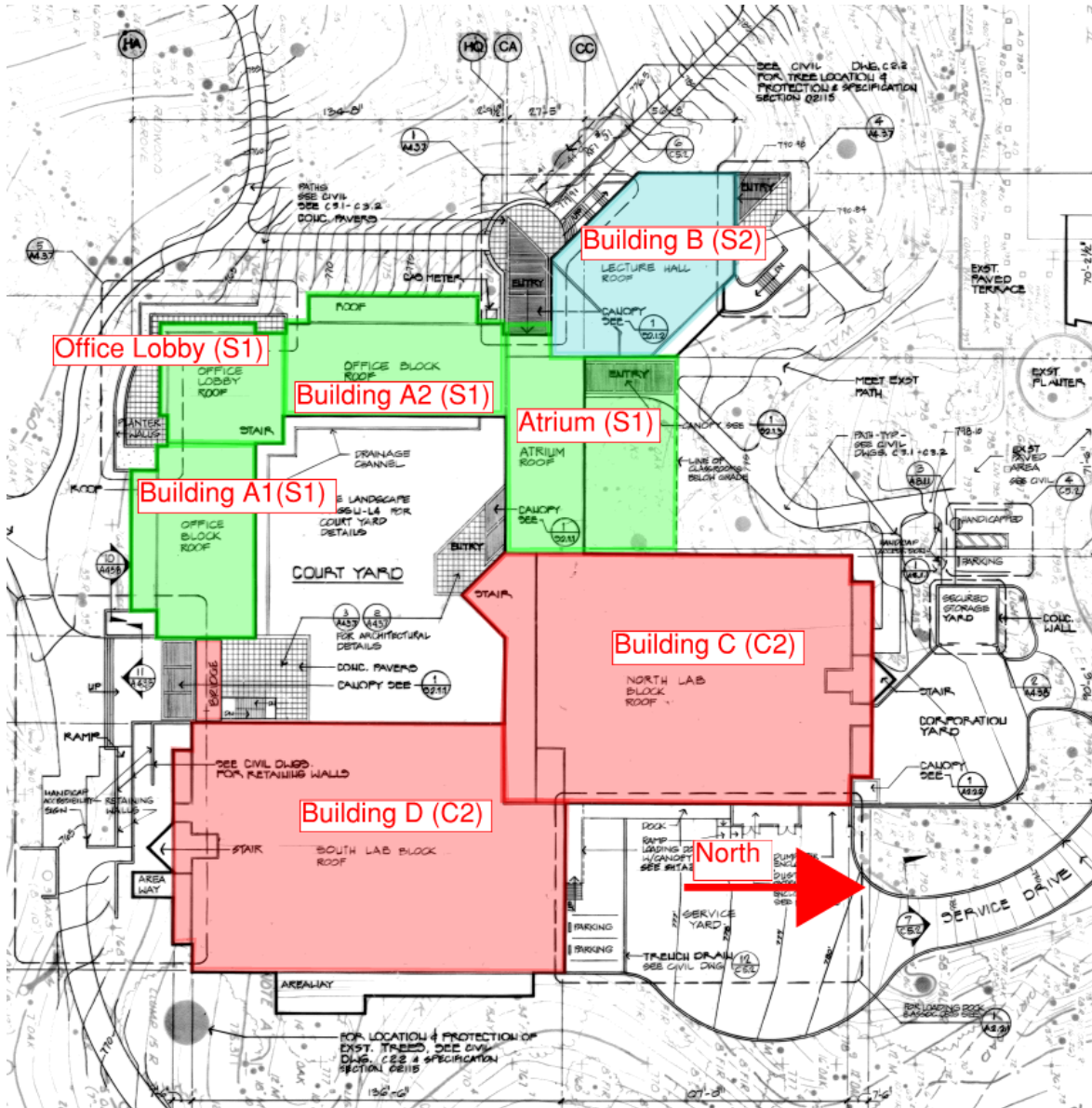

Structural Plan Level 1 Sheet S2.1.2 Marked with Moment Frame Locations

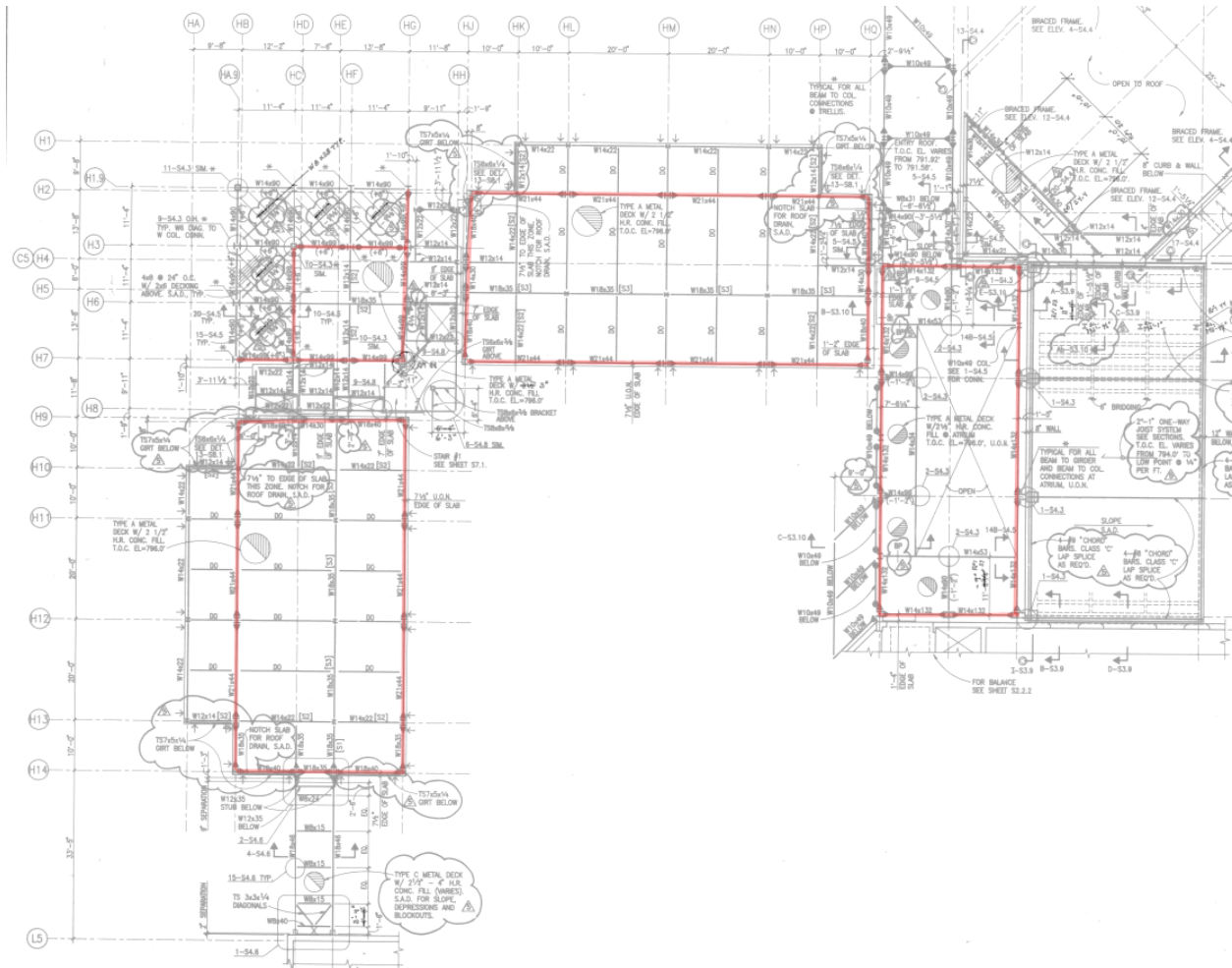

Architectural Section thru Atrium, Office A2, and Lobby

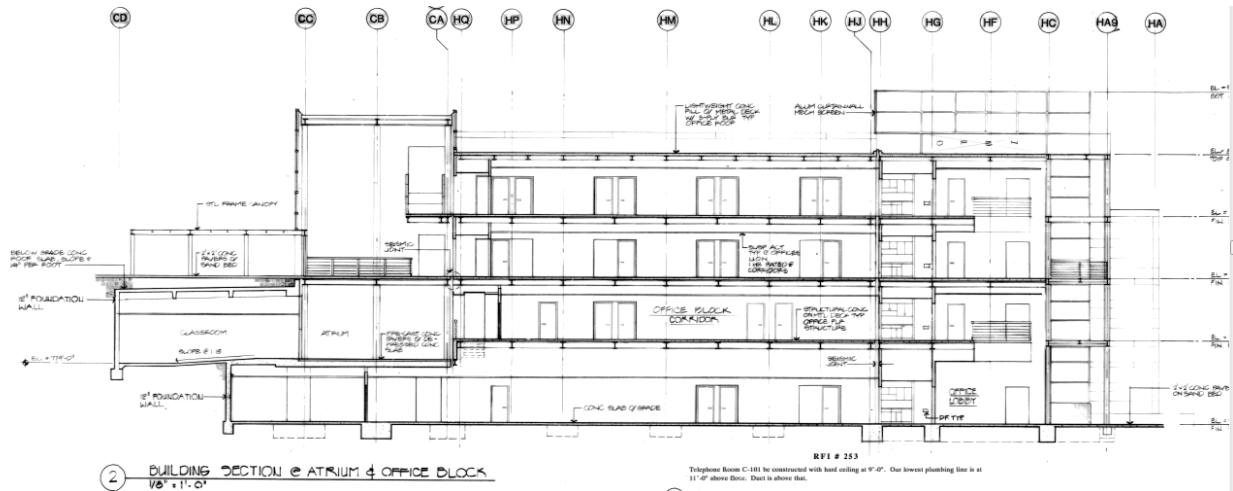

Typical Moment Connection Details 10/S4.2

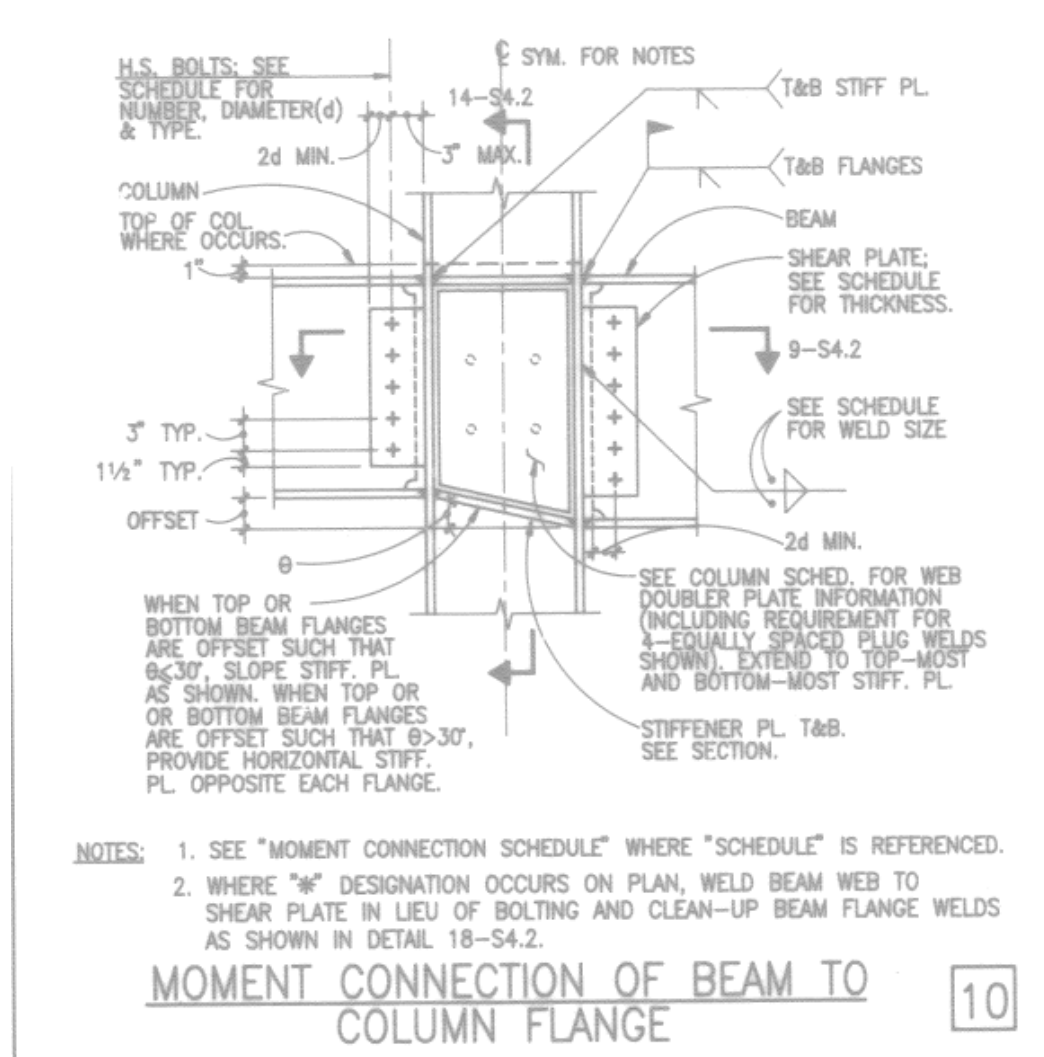

Typical Moment Connection at Exposed Joints in Atrium and Lobby Curtain Wall

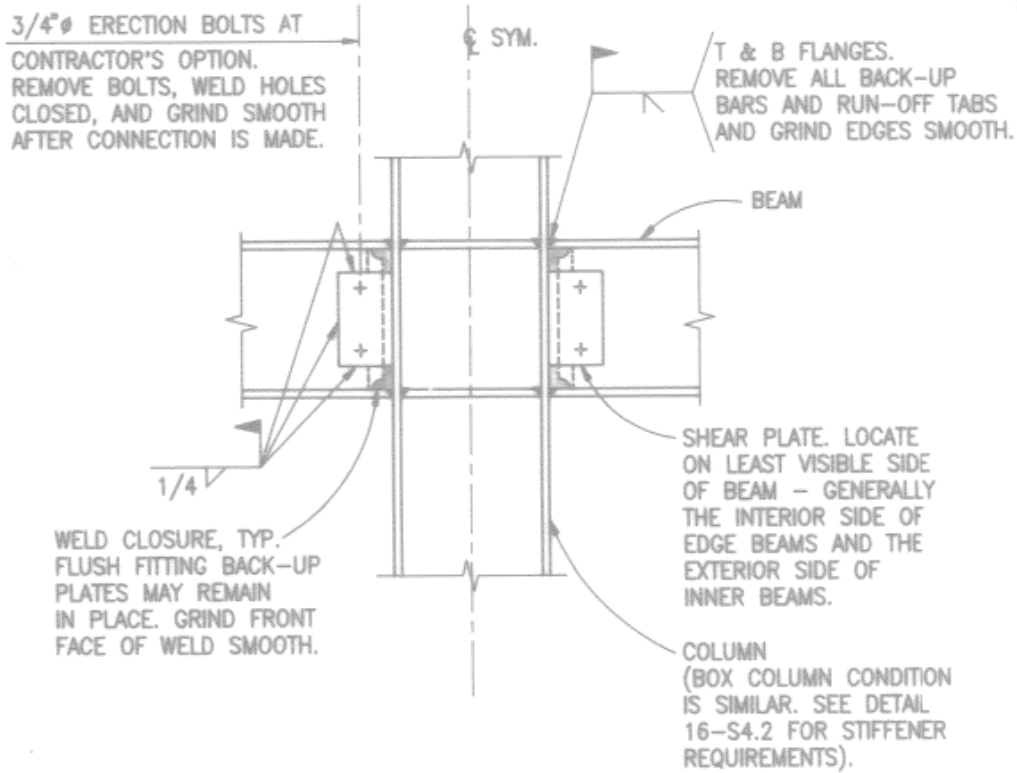

NOTE: SEE DETAIL 10-S4.2 FOR INFORMATION NOT SHOWN OR NOTED.

MOMENT CONNECTION OF BEAM TO COLUMN FLANGE ALONG CURTAIN WALL 18



APPENDIX A

Additional Photos

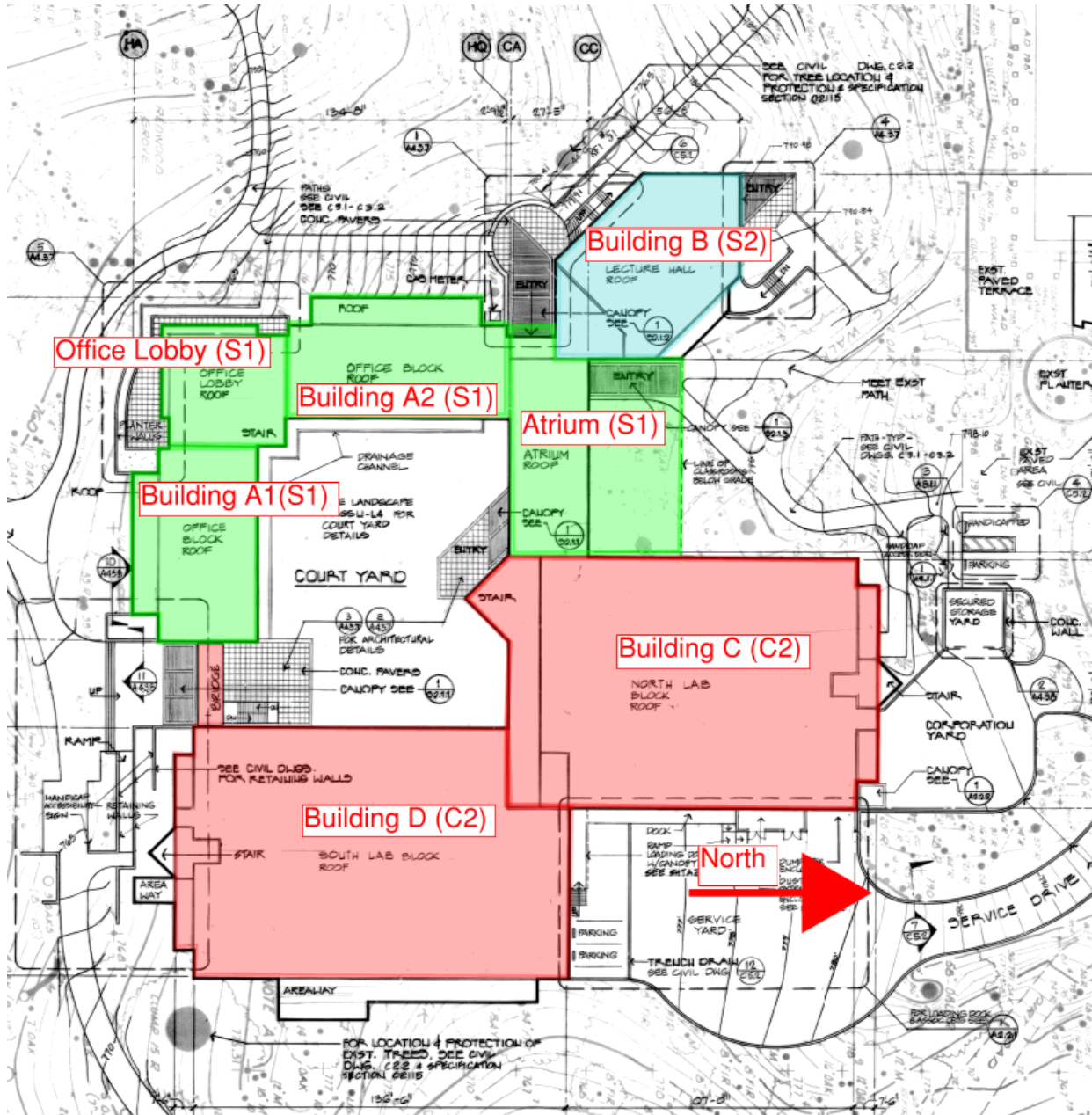

Plan Showing Building Designations (Office Blocks A1 and A2, Lobby and Atrium S1 Steel Moment Frames)



West Elevation Office Block A2 (Center), Lobby (Right), Lecture Hall (Left, Looking Southeast)



West Elevation Office Block A2 with Lobby at Far Right (Looking Northeast)



West Elevation Lobby Exposed Framing and Full-Height Glazing at Southwest Corner (Looking Southeast)



Lobby Entry at Southwest Corner



Detail South Elevation Lobby Exposed Framing with Office Block A1 at Right (Looking Northeast)



South Elevation Office Block A1 (Right) and Lobby (Left, Looking Northwest)



South Elevation Office Block A1 (Left), Bridges (Center), Lab Block D (Right)

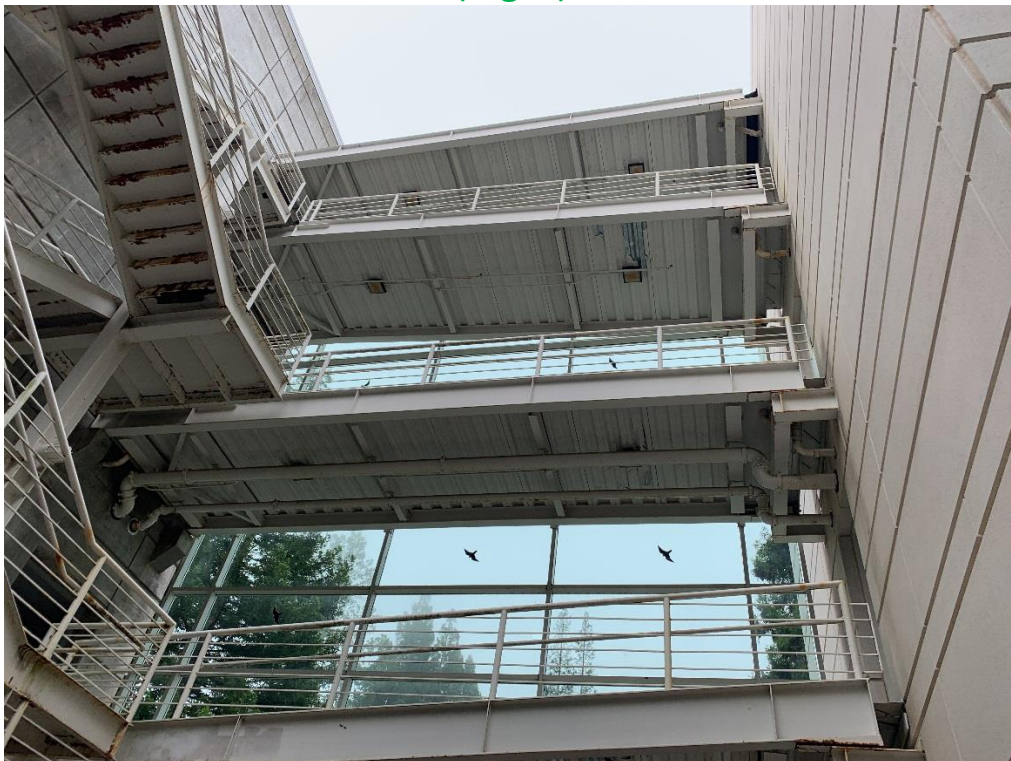

View of Bridges Looking South (Glazing on South Side Only)



Bridge Seat (Looking South with Office Block A1 at Right, Glazing Beyond)



Bridge Anchored to Lab Block D at Right (Looking Northeast)



North Elevation with Atrium Entry



Glazing at West Atrium Entry (Looking East, Office Block A2 at Right)



Atrium Interior View at Second Floor (Looking Southwest out to Courtyard)



Atrium Interior View at Second Floor (Looking Northwest)



Interior View of Detail at Atrium Window Mullions at North Elevation



Interior View of Atrium Exposed Framing and Glazing from Café at Lowest Level of Steel Framing (Looking Southwest)



APPENDIX B

ASCE 41-17 Tier 1 Checklists (Structural)

UC Campus:	Santa Cruz			Date:	06/28/2019		
Building CAAN:	7775.1	Auxiliary CAAN:		By Firm:	Rutherford + Chekene		
Building Name:	Earth & Marine Sciences (A1, A2, Lobby, Atrium)			Initials:	CLP, EFA	Checked:	WAL/BL
Building Address:	552 Red Hill Road, Santa Cruz, CA 95064			Page:	1	of	3

ASCE 41-17 Collapse Prevention Basic Configuration Checklist

LOW SEISMICITY

BUILDING SYSTEMS - GENERAL

	Description
C NC N/A U <input checked="" type="radio"/> <input type="radio"/> <input type="radio"/> <input type="radio"/>	<p>LOAD PATH: The structure contains a complete, well-defined load path, including structural elements and connections, that serves to transfer the inertial forces associated with the mass of all elements of the building to the foundation. (Commentary: Sec. A.2.1.1. Tier 2: Sec. 5.4.1.1)</p> <p>Comments: General comment: Original design by R+C and structural calculations available for review.</p>
C NC N/A U <input type="radio"/> <input checked="" type="radio"/>	<p>ADJACENT BUILDINGS: The clear distance between the building being evaluated and any adjacent building is greater than 0.25% of the height of the shorter building in low seismicity, 0.5% in moderate seismicity, and 1.5% in high seismicity. (Commentary: Sec. A.2.1.2. Tier 2: Sec. 5.4.1.2)</p> <p>Comments: Gap required is 52'x12"x0.015=9.36". Gap provided is 3".</p>
C NC N/A U <input type="radio"/> <input type="radio"/> <input checked="" type="radio"/> <input type="radio"/>	<p>MEZZANINES: Interior mezzanine levels are braced independently from the main structure or are anchored to the seismic-force-resisting elements of the main structure. (Commentary: Sec. A.2.1.3. Tier 2: Sec. 5.4.1.3)</p> <p>Comments: There are no mezzanine levels in the Office Blocks.</p>

BUILDING SYSTEMS - BUILDING CONFIGURATION

	Description
C NC N/A U <input checked="" type="radio"/> <input type="radio"/> <input type="radio"/> <input type="radio"/>	<p>WEAK STORY: The sum of the shear strengths of the seismic-force-resisting system in any story in each direction is not less than 80% of the strength in the adjacent story above. (Commentary: Sec. A.2.2.2. Tier 2: Sec. 5.4.2.1)</p> <p>Comments: Similar framing at all levels.</p>
C NC N/A U <input checked="" type="radio"/> <input type="radio"/> <input type="radio"/> <input type="radio"/>	<p>SOFT STORY: The stiffness of the seismic-force-resisting system in any story is not less than 70% of the seismic-force-resisting system stiffness in an adjacent story above or less than 80% of the average seismic-force-resisting system stiffness of the three stories above. (Commentary: Sec. A.2.2.3. Tier 2: Sec. 5.4.2.2)</p> <p>Comments: Similar framing at all levels.</p>
C NC N/A U <input checked="" type="radio"/> <input type="radio"/> <input type="radio"/> <input type="radio"/>	<p>VERTICAL IRREGULARITIES: All vertical elements in the seismic-force-resisting system are continuous to the foundation. (Commentary: Sec. A.2.2.4. Tier 2: Sec. 5.4.2.3)</p> <p>Comments: All columns continuous.</p>

Note: C = Compliant NC = Noncompliant N/A = Not Applicable U = Unknown

UC Campus:	Santa Cruz			Date:	06/28/2019		
Building CAAN:	7775.1	Auxiliary CAAN:		By Firm:	Rutherford + Chekene		
Building Name:	Earth & Marine Sciences (A1, A2, Lobby, Atrium)			Initials:	CLP, EFA	Checked:	WAL/BL
Building Address:	552 Red Hill Road, Santa Cruz, CA 95064			Page:	2	of	3

ASCE 41-17 Collapse Prevention Basic Configuration Checklist

C <input checked="" type="radio"/> NC <input type="radio"/> N/A <input type="radio"/> U <input type="radio"/>	<p>GEOMETRY: There are no changes in the net horizontal dimension of the seismic-force-resisting system of more than 30% in a story relative to adjacent stories, excluding one-story penthouses and mezzanines. (Commentary: Sec. A.2.2.5. Tier 2: Sec. 5.4.2.4)</p> <p>Comments: Plan similar at all floors.</p>
C <input checked="" type="radio"/> NC <input type="radio"/> N/A <input type="radio"/> U <input type="radio"/>	<p>MASS: There is no change in effective mass of more than 50% from one story to the next. Light roofs, penthouses, and mezzanines need not be considered. (Commentary: Sec. A.2.2.6. Tier 2: Sec. 5.4.2.5)</p> <p>Comments: Plan and layout similar at all floors of the office buildings A1 and A2. (Lobby and Atrium do not have complete floor levels.)</p>
C <input checked="" type="radio"/> NC <input type="radio"/> N/A <input type="radio"/> U <input type="radio"/>	<p>TORSION: The estimated distance between the story center of mass and the story center of rigidity is less than 20% of the building width in either plan dimension. (Commentary: Sec. A.2.2.7. Tier 2: Sec. 5.4.2.6)</p> <p>Comments: Floor layout and mass distribution similar at all floor of office buildings.</p>

MODERATE SEISMICITY (COMPLETE THE FOLLOWING ITEMS IN ADDITION TO THE ITEMS FOR LOW SEISMICITY)

GEOLOGIC SITE HAZARD

	Description
C <input checked="" type="radio"/> NC <input type="radio"/> N/A <input type="radio"/> U <input type="radio"/>	<p>LIQUEFACTION: Liquefaction-susceptible, saturated, loose granular soils that could jeopardize the building's seismic performance do not exist in the foundation soils at depths within 50 ft (15.2m) under the building. (Commentary: Sec. A.6.1.1. Tier 2: 5.4.3.1)</p> <p>Comments: There is no mapped liquefaction on https://gis.santacruzcounty.us/mapgallery/Emergency%20Management/Hazard%20Mitigation/LiquifactionMap2009.pdf .</p>
C <input checked="" type="radio"/> NC <input type="radio"/> N/A <input type="radio"/> U <input type="radio"/>	<p>SLOPE FAILURE: The building site is located away from potential earthquake-induced slope failures or rockfalls so that it is unaffected by such failures or is capable of accommodating any predicted movements without failure. (Commentary: Sec. A.6.1.2. Tier 2: 5.4.3.1)</p> <p>Comments: There are no mapped landslides on https://gis.santacruzcounty.us/mapgallery/Emergency%20Management/Hazard%20Mitigation/LandslideMap2009.pdf</p>

Note: C = Compliant NC = Noncompliant N/A = Not Applicable U = Unknown

UC Campus:	Santa Cruz			Date:	06/28/2019		
Building CAAN:	7775.1	Auxiliary CAAN:		By Firm:	Rutherford + Chekene		
Building Name:	Earth & Marine Sciences (A1, A2, Lobby, Atrium)			Initials:	CLP, EFA	Checked:	WAL/BL
Building Address:	552 Red Hill Road, Santa Cruz, CA 95064			Page:	3	of	3

ASCE 41-17 Collapse Prevention Basic Configuration Checklist

MODERATE SEISMICITY (COMPLETE THE FOLLOWING ITEMS IN ADDITION TO THE ITEMS FOR LOW SEISMICITY)

GEOLOGIC SITE HAZARD

C <input checked="" type="radio"/> NC <input type="radio"/> N/A <input type="radio"/> U <input type="radio"/>	<p>SURFACE FAULT RUPTURE: Surface fault rupture and surface displacement at the building site are not anticipated. (Commentary: Sec. A.6.1.3. Tier 2: 5.4.3.1)</p> <p>Comments: There are no faults at the project site per https://gis.santacruzcounty.us/mapgallery/Emergency%20Management/Hazard%20Mitigation/FaultZoneMap2009.pdf.</p>
---	--

HIGH SEISMICITY (COMPLETE THE FOLLOWING ITEMS IN ADDITION TO THE ITEMS FOR MODERATE SEISMICITY)

FOUNDATION CONFIGURATION

	Description
C <input type="radio"/> NC <input checked="" type="radio"/> N/A <input type="radio"/> U <input type="radio"/>	<p>OVERTURNING: The ratio of the least horizontal dimension of the seismic-force-resisting system at the foundation level to the building height (base/height) is greater than $0.6S_a$. (Commentary: Sec. A.6.2.1. Tier 2: Sec. 5.4.3.3)</p> <p>Comments: Transverse Frame width $B = 33.5'$, Building Height is $H = 52'$, $B/H = 0.644$ $S_a = 1.07g$ per ATC at BSE-2E $0.6 \times S_a = 0.64$ $B/H < 0.6 S_a$ for A1, A2 (Lobby and Atrium have smaller transverse dimensions and are noncompliant.)</p>
C <input checked="" type="radio"/> NC <input type="radio"/> N/A <input type="radio"/> U <input type="radio"/>	<p>TIES BETWEEN FOUNDATION ELEMENTS: The foundation has ties adequate to resist seismic forces where footings, piles, and piers are not restrained by beams, slabs, or soils classified as Site Class A, B, or C. (Commentary: Sec. A.6.2.2. Tier 2: Sec. 5.4.3.4)</p> <p>Comments: Site Class D per Geotech. All foundation elements tied together with continuous strip footings.</p>

Note: C = Compliant NC = Noncompliant N/A = Not Applicable U = Unknown

UC Campus:	Santa Cruz			Date:	06/28/2019		
Building CAAN:	7775.1	Auxiliary CAAN:		By Firm:	Rutherford + Chekene		
Building Name:	Earth & Marine Sciences (A1, A2, Lobby, Atrium)			Initials:	CLP, EFA	Checked:	WAL/BL
Building Address:	552 Red Hill Road, Santa Cruz, CA 95064			Page:	1	of	4

ASCE 41-17 Collapse Prevention Structural Checklist For Building Type S1-S1A

LOW SEISMICITY							
SEISMIC-FORCE-RESISTING SYSTEM							
				Description			
C	NC	N/A	U	REDUNDANCY: The number of lines of moment frames in each principal direction is greater than or equal to 2. (Commentary: Sec. A.3.1.1.1. Tier 2: Sec. 5.5.1.1)			
<input checked="" type="radio"/>	<input type="radio"/>	<input type="radio"/>	<input type="radio"/>	Comments: All have moment frames at perimeter; two each way. Lobby has 3 in one frame 2 in other.			
C	NC	N/A	U	DRIFT CHECK: The drift ratio of the steel moment frames, calculated using the Quick Check procedure of Section 4.4.3.1, is less than 0.030. (Commentary: Sec. A.3.1.3.1. Tier 2: Sec. 5.5.2.1.2)			
<input type="radio"/>	<input checked="" type="radio"/>	<input type="radio"/>	<input type="radio"/>	Comments: Performed Quick Check for longitudinal frames of both A1 and A2; not compliant at lower 2 floors; would be higher drift in transverse direction. Quick Check for Lobby ok at all floors. Did not check Atrium Building.			
C	NC	N/A	U	COLUMN AXIAL STRESS CHECK: The axial stress caused by gravity loads in columns subjected to overturning forces is less than $0.10F_y$. Alternatively, the axial stress caused by overturning forces alone, calculated using the Quick Check procedure of Section 4.4.3.6, is less than $0.30F_y$. (Commentary: Sec. A.3.1.3.2. Tier 2: Sec. 5.5.2.1.3)			
<input checked="" type="radio"/>	<input type="radio"/>	<input type="radio"/>	<input type="radio"/>	Comments: Performed Quick check for A1 and A2; both ok.			
C	NC	N/A	U	FLEXURAL STRESS CHECK: The average flexural stress in the moment frame columns and beams, calculated using the Quick Check procedure of Section 4.4.3.9, is less than F_y . Columns need not be checked if the strong column-weak beam checklist item is compliant. (Commentary: Sec. A.3.1.3.3. Tier 2: Sec. 5.5.2.1.2)			
<input checked="" type="radio"/>	<input type="radio"/>	<input type="radio"/>	<input type="radio"/>	Comments: Performed Quick check for average flexural stress for A2 and average stress 17.5ksi. OK			
CONNECTIONS							
				Description			
C	NC	N/A	U	TRANSFER TO STEEL FRAMES: Diaphragms are connected for transfer of seismic forces to the steel frames. (Commentary: Sec. A.5.2.2. Tier 2: Sec. 5.7.2)			
<input checked="" type="radio"/>	<input type="radio"/>	<input type="radio"/>	<input type="radio"/>	Comments: Metal deck connected to framing with pattern of welded studs.			
C	NC	N/A	U	STEEL COLUMNS: The columns in seismic-force-resisting frames are anchored to the building foundation. (Commentary: Sec. A.5.3.1. Tier 2: Sec. 5.7.3.1)			
<input checked="" type="radio"/>	<input type="radio"/>	<input type="radio"/>	<input type="radio"/>	Comments: Base of columns has base plate and 1-1/2" dia. anchor bolts.			

Note: **C** = Compliant **NC** = Noncompliant **N/A** = Not Applicable **U** = Unknown

UC Campus:	Santa Cruz			Date:	06/28/2019		
Building CAAN:	7775.1	Auxiliary CAAN:		By Firm:	Rutherford + Chekene		
Building Name:	Earth & Marine Sciences (A1, A2, Lobby, Atrium)			Initials:	CLP, EFA	Checked:	WAL/BL
Building Address:	552 Red Hill Road, Santa Cruz, CA 95064			Page:	2	of	4

ASCE 41-17
Collapse Prevention Structural Checklist For Building Type S1-S1A

MODERATE SEISMICITY (COMPLETE THE FOLLOWING ITEMS IN ADDITION TO THE ITEMS FOR LOW SEISMICITY)

SEISMIC-FORCE-RESISTING SYSTEM

	Description
C NC N/A U <input type="radio"/> <input checked="" type="radio"/> <input type="radio"/> <input type="radio"/>	REDUNDANCY: The number of bays of moment frames in each line is greater than or equal to 2. (Commentary: Sec. A.3.1.1.1. Tier 2: Sec. 5.5.1.1) Comments: Transverse frames for A1 and A2 have 3 bays, Lobby has 4 bays; Atrium has 2 bays.
C NC N/A U <input type="radio"/> <input type="radio"/> <input checked="" type="radio"/> <input type="radio"/>	INTERFERING WALLS: All concrete and masonry infill walls placed in moment frames are isolated from structural elements. (Commentary: Sec. A.3.1.2.1. Tier 2: Sec. 5.5.2.1.1) Comments: No interfering infill walls.
C NC N/A U <input type="radio"/> <input checked="" type="radio"/> <input type="radio"/> <input type="radio"/>	MOMENT-RESISTING CONNECTIONS: All moment connections can develop the strength of the adjoining members based on the specified minimum yield stress of steel. (Commentary: Sec. A.3.1.3.4. Tier 2: Sec. 5.5.2.2.1). Comments: 1990 Pre-Northridge connections noncompliant.

HIGH SEISMICITY (COMPLETE THE FOLLOWING ITEMS IN ADDITION TO THE ITEMS FOR LOW AND MODERATE SEISMICITY)

SEISMIC-FORCE-RESISTING SYSTEM

	Description
C NC N/A U <input type="radio"/> <input checked="" type="radio"/> <input type="radio"/> <input type="radio"/>	MOMENT-RESISTING CONNECTIONS: All moment connections are able to develop the strength of the adjoining members or panel zones based on 110% of the expected yield stress of the steel in accordance with AISC 341, Section A3.2. (Commentary: Sec. A.3.1.3.4. Tier 2: Sec. 5.5.2.2.1) Comments: 1990 Pre-Northridge connections noncompliant.
C NC N/A U <input type="radio"/> <input checked="" type="radio"/> <input type="radio"/> <input type="radio"/>	PANEL ZONES: All panel zones have the shear capacity to resist the shear demand required to develop 0.8 times the sum of the flexural strengths of the girders framing in at the face of the column. (Commentary: Sec. A.3.1.3.5. Tier 2: Sec. 5.5.2.2.2) Comments: 1990 Pre-Northridge connections noncompliant.

Note: **C** = Compliant **NC** = Noncompliant **N/A** = Not Applicable **U** = Unknown

UC Campus:	Santa Cruz			Date:	06/28/2019		
Building CAAN:	7775.1	Auxiliary CAAN:		By Firm:	Rutherford + Chekene		
Building Name:	Earth & Marine Sciences (A1, A2, Lobby, Atrium)			Initials:	CLP, EFA	Checked:	WAL/BL
Building Address:	552 Red Hill Road, Santa Cruz, CA 95064			Page:	3	of	4

ASCE 41-17 Collapse Prevention Structural Checklist For Building Type S1-S1A

C <input checked="" type="radio"/> NC <input type="radio"/> N/A <input type="radio"/> U <input type="radio"/>	<p>COLUMN SPLICES: All column splice details located in moment-resisting frames include connection of both flanges and the web. (Commentary: Sec. A.3.1.3.6. Tier 2: Sec. 5.5.2.2.3)</p> <p>Comments: Pre-Northridge; web has partial penetration welds; flange has full penetration welds.</p>
C <input type="radio"/> NC <input checked="" type="radio"/> N/A <input type="radio"/> U <input type="radio"/>	<p>STRONG COLUMN—WEAK BEAM: The percentage of strong column–weak beam joints in each story of each line of moment frames is greater than 50%. (Commentary: Sec. A.3.1.3.7. Tier 2: Sec. 5.5.2.1.5)</p> <p>Comments: 1990 Pre-Northridge connections noncompliant. (Checked typical connection for A1 and A2 and ratio of column flexural strength to beam flexural strength = 0.69 (<1) in typical connections.)</p>
C <input checked="" type="radio"/> NC <input type="radio"/> N/A <input type="radio"/> U <input type="radio"/>	<p>COMPACT MEMBERS: All frame elements meet section requirements in accordance with AISC 341, Table D1.1, for moderately ductile members. (Commentary: Sec. A.3.1.3.8. Tier 2: Sec. 5.5.2.2.4)</p> <p>Comments: Checked typical moment framing for A1 and A2 and all ok.</p>

DIAPHRAGMS (STIFF OR FLEXIBLE)

	Description
C <input type="radio"/> NC <input checked="" type="radio"/> N/A <input type="radio"/> U <input type="radio"/>	<p>OPENINGS AT FRAMES: Diaphragm openings immediately adjacent to the moment frames extend less than 25% of the total frame length. (Commentary: Sec. A.4.1.5. Tier 2: Sec. 5.6.1.3)</p> <p>Comments: Compliant for A1 and A2. Note this item not compliant for Lobby and Atrium that have large open floor areas.</p>

FLEXIBLE DIAPHRAGMS

	Description
C <input type="radio"/> NC <input type="radio"/> N/A <input checked="" type="radio"/> U <input type="radio"/>	<p>CROSS TIES: There are continuous cross ties between diaphragm chords. (Commentary: Sec. A.4.1.2. Tier 2: Sec. 5.6.1.2)</p> <p>Comments: Diaphragms metal deck and fill at office A1 and A2. (Incomplete diaphragm framing at Atrium and Lobby.)</p>
C <input type="radio"/> NC <input type="radio"/> N/A <input checked="" type="radio"/> U <input type="radio"/>	<p>STRAIGHT SHEATHING: All straight-sheathed diaphragms have aspect ratios less than 2-to-1 in the direction being considered. (Commentary: Sec. A.4.2.1. Tier 2: Sec. 5.6.2)</p> <p>Comments: No wood diaphragms.</p>
C <input type="radio"/> NC <input type="radio"/> N/A <input checked="" type="radio"/> U <input type="radio"/>	<p>SPANS: All wood diaphragms with spans greater than 24 ft (7.3 m) consist of wood structural panels or diagonal sheathing. (Commentary: Sec. A.4.2.2. Tier 2: Sec. 5.6.2)</p> <p>Comments: No wood diaphragms.</p>

Note: **C** = Compliant **NC** = Noncompliant **N/A** = Not Applicable **U** = Unknown

UC Campus:	Santa Cruz		Date:	06/28/2019		
Building CAAN:	7775.1	Auxiliary CAAN:	By Firm:	Rutherford + Chekene		
Building Name:	Earth & Marine Sciences (A1, A2, Lobby, Atrium)		Initials:	CLP, EFA	Checked:	WAL/BL
Building Address:	552 Red Hill Road, Santa Cruz, CA 95064		Page:	4	of	4

ASCE 41-17
Collapse Prevention Structural Checklist For Building Type S1-S1A

C	NC	N/A	U	<p>DIAGONALLY SHEATHED AND UNBLOCKED DIAPHRAGMS: All diagonally sheathed or unblocked wood structural panel diaphragms have horizontal spans less than 40 ft (12.2 m) and aspect ratios less than or equal to 4-to-1. (Commentary: Sec. A.4.2.3. Tier 2: Sec. 5.6.2)</p> <p>Comments: No wood diaphragms.</p>
<input type="radio"/>	<input type="radio"/>	<input checked="" type="radio"/>	<input type="radio"/>	
C	NC	N/A	U	<p>OTHER DIAPHRAGMS: Diaphragms do not consist of a system other than wood, metal deck, concrete, or horizontal bracing. (Commentary: Sec. A.4.7.1. Tier 2: Sec. 5.6.5)</p> <p>Comments: Diaphragms are metal deck and fill.</p>
<input type="radio"/>	<input type="radio"/>	<input checked="" type="radio"/>	<input type="radio"/>	

Note: **C** = Compliant **NC** = Noncompliant **N/A** = Not Applicable **U** = Unknown



UCSC

APPENDIX C

UCOP Seismic Safety Policy Falling Hazards Assessment Summary

UC Campus:	Santa Cruz			Date:	06/28/2019		
Building CAAN:	7775.1	Auxiliary CAAN:		By Firm:	Rutherford + Chekene		
Building Name:	Earth & Marine Sciences (A1, A2, Lobby, Atrium)			Initials:	CLP, EFA	Checked:	WAL/BL
Building Address:	552 Red Hill Road, Santa Cruz, CA 95064			Page:	1	of	1

UCOP SEISMIC SAFETY POLICY Falling Hazard Assessment Summary

	Description
P N/A <input type="checkbox"/> <input checked="" type="checkbox"/>	<p>Heavy ceilings, features or ornamentation above large lecture halls, auditoriums, lobbies, or other areas where large numbers of people congregate (50 ppl or more)</p> <p>Comments: There are no heavy ceilings, features, or ornamentation. See comment below regarding glazing in Lobby and Atrium.</p>
P N/A <input type="checkbox"/> <input checked="" type="checkbox"/>	<p>Heavy masonry or stone veneer above exit ways or public access areas</p> <p>Comments: There is no masonry or stone veneer.</p>
P N/A <input type="checkbox"/> <input checked="" type="checkbox"/>	<p>Unbraced masonry parapets, cornices, or other ornamentation above exit ways or public access areas</p> <p>Comments: There are no masonry parapets, cornices or other ornamentation.</p>
P N/A <input type="checkbox"/> <input checked="" type="checkbox"/>	<p>Unrestrained hazardous material storage</p> <p>Comments: No hazardous material storage was observed.</p>
P N/A <input type="checkbox"/> <input checked="" type="checkbox"/>	<p>Masonry chimneys</p> <p>Comments: There are no masonry chimneys.</p>
P N/A <input type="checkbox"/> <input checked="" type="checkbox"/>	<p>Unrestrained natural gas-fueled equipment such as water heaters, boilers, emergency generators, etc.</p> <p>Comments: Unknown.</p>
P N/A <input checked="" type="checkbox"/> <input type="checkbox"/>	<p>Other: Full height glazing in Lobby and Atrium that serve as exits for entire complex of office buildings, Lab, and Lecture Hall. Full height glazing adjacent to bridge from Office Block to Lab Block on south side of complex.</p> <p>Comments: We recommend this be checked by the University to confirm the glazing is tempered or the like.</p>
P N/A <input type="checkbox"/> <input checked="" type="checkbox"/>	<p>Other:</p> <p>Comments:</p>
P N/A <input type="checkbox"/> <input type="checkbox"/>	<p>Other:</p> <p>Comments:</p>

Falling Hazards Risk: **Moderate**



APPENDIX D

Quick Check Calculations

Unit Weights:

Unit weight were not calculated because we had the original design calcaultions shown below

RUTHERFORD & CHEKENE | CONSULTING
a california corporation | ENGINEERS

303 Second Street, Suite 800 North
San Francisco, California 94107
Tel: (415) 495-4222 Fax: (415) 546-7536

Project EMS
Subject H Block - South Bldg
Job No. 880175 By HF
Date 7-5-89 Sheet 502

SEISMIC WEIGHTS

$$\begin{aligned} \text{Roof} &= 35.34' \times 72' \times 54 \text{psf} &= 137.4^k \\ &+ 687 \text{plf} \times 215' &= 147.7 \\ \hline W_R &= 285.1^k \end{aligned}$$

$$\begin{aligned} \text{Levels 3 \& 2} &= 35.34 \times 72 \times 96 \text{psf} &= 244.3 \\ &+ 9.67' \times 52' \times 96 &= 48.3 \\ &+ 549 \text{plf} \times 234' &= 128.5 \\ \text{Bridge} &= 96 \text{psf} \times 7' \times 27' &= 18.1^k \\ \hline W_{3,2} &= 439.2^k_{(E-W)} = 430.2^k_{(N-S)} \end{aligned}$$

$$\begin{aligned} \text{Level 1} &= 35.34 \times 72 \times 96 &= 244.3 \\ &+ 9.67 \times 52 \times 96 &= 48.3 \\ &+ 790 \text{plf} \times 234' &= 184.9 \\ \text{Bridge} &= 96 \times 7 \times 27 &= 18.1^k_{(1/2)} \\ \hline W_1 &= 495.6^k_{(E-W)} = 486.6^k_{(N-S)} \end{aligned}$$

$$\begin{aligned} W_{\text{Base}} &\rightarrow \text{North-South Direction} \\ &= 285.1 + (430.2)2 + 486.6 = 1632^k \end{aligned}$$

$$\begin{aligned} W_{\text{Base}} &\rightarrow \text{East - West Direction} \\ &= 285.1 + (439.2)2 + 495.6 = 1659^k \end{aligned}$$

Story Weights

This is the summary of the story weight obtained from calculations

Building A1		
Floor	Weight (kip)	Total weight (kip)
roof	285.1	
3	439.2	
2	439.2	
1	495.6	
		1659.1

Period

Period is calculated using Mathcad and is attached with the Mathcad calculations below

BSE-2E Response Spectrum

ATC Hazards by Location

Search by Address Search by Coordinate

36.997938 -122.059722 Search

Wind
 Snow
 Tornado
 Seismic

Hazard Level BSE-2E

Name	Value	Description
S _g	1.283	MCE _R ground motion (period=0.2s)
F _a	1	Site amplification factor at 0.2s
S _{Xg}	1.283	Site modified spectral response (0.2s)
S ₁	0.487	MCE _R ground motion (period=1.0s)
F _v	1.813	Site amplification factor at 1.0s
S _{X1}	0.882	Site modified spectral response (1.0s)

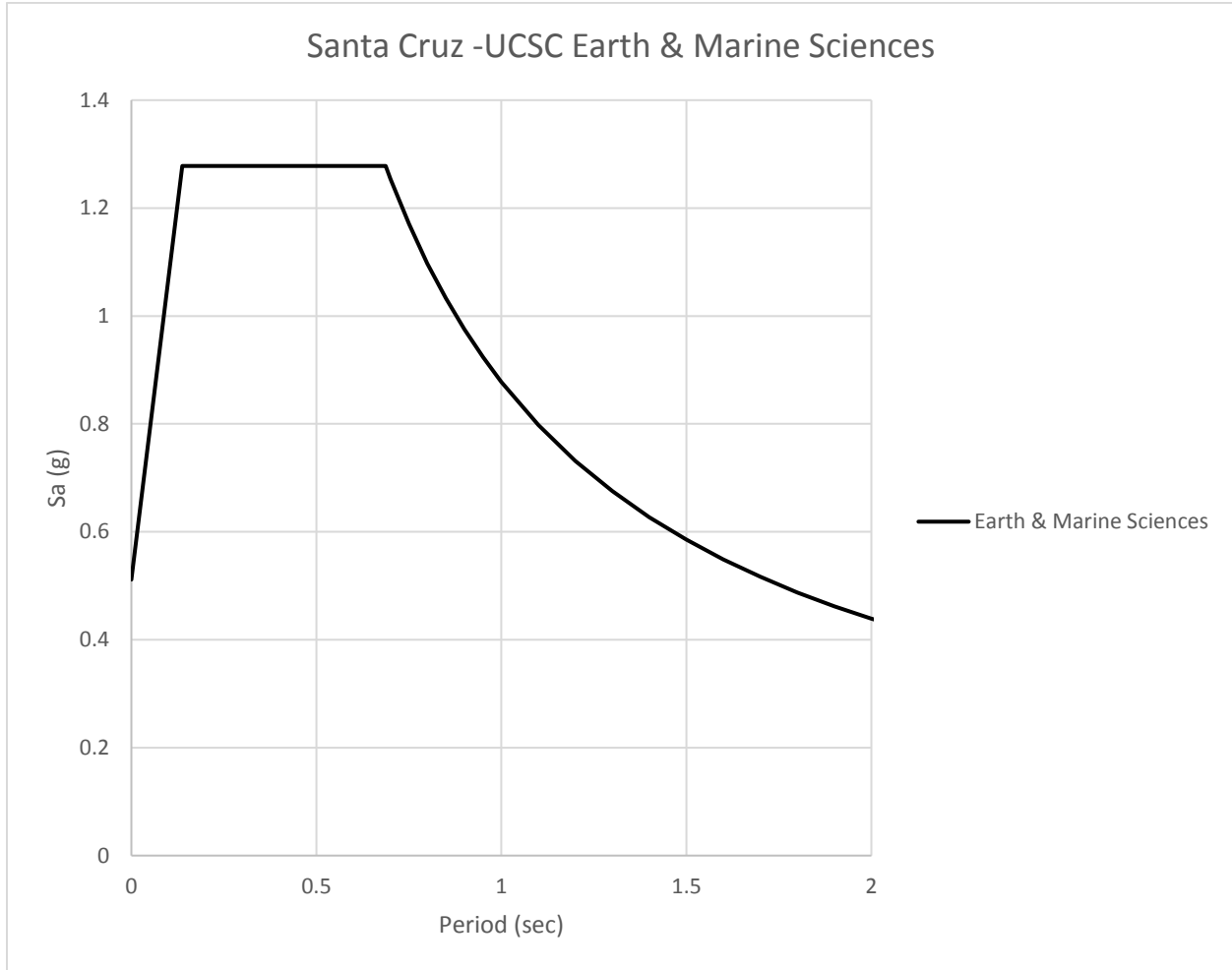



Rating form completed by:

RUTHERFORD + CHEKENE
ruthchek.com

Evaluator: CLP/EFA/WAL/BL

Date: 06/28/2019

Calculations required for checklist were performed using the program Mathcad, and are attached in the following pages



UCSC

Building A1 Drift check

Calculation of drift quick check according to ASCE 41-17

drift limit $D_{r\text{limit}} := 0.03$

$$D_r = \left(\frac{k_b + k_c}{k_b k_c} \right) \left(\frac{h}{12E} \right) V_c \quad (4-6)$$

where

D_r = Drift ratio: interstory displacement divided by story height;

k_b = I/L for the representative beam;

k_c = I/h for the representative column;

h = Story height (in.);

I = Moment of inertia (in.⁴);

L = Beam length from center-to-center of adjacent columns (in.);

E = Modulus of elasticity (kip/in.²); and

V_c = Shear in the column (kip).

$$I_{b1} := 843 \text{ in}^4 \quad L_{b1} := 20 \times 12 \text{ in} = 240 \cdot \text{in} \quad I_{c1} := 1240 \text{ in}^4 \quad h_{c1} := 16 \cdot 12 \text{ in} = 192 \cdot \text{in}$$

$$I_{b2} := 843 \text{ in}^4 \quad L_{b2} := 20 \times 12 \text{ in} = 240 \cdot \text{in} \quad I_{c2} := 795 \text{ in}^4 \quad h_{c2} := 12 \times 12 \text{ in} = 144 \cdot \text{in}$$

$$I_{b3} := 843 \text{ in}^4 \quad L_{b3} := 20 \times 12 \text{ in} = 240 \cdot \text{in} \quad I_{c3} := 795 \text{ in}^4 \quad h_{c3} := 12 \times 12 \text{ in} = 144 \cdot \text{in}$$

$$k_{b1} := \frac{I_{b1}}{L_{b1}} = 3.5125 \cdot \text{in}^3 \quad k_{c1} := \frac{I_{c1}}{h_{c1}} = 6.458 \cdot \text{in}^3$$

$$k_{b2} := \frac{I_{b2}}{L_{b2}} = 3.5125 \cdot \text{in}^3 \quad k_{c2} := \frac{I_{c2}}{h_{c2}} = 5.521 \cdot \text{in}^3$$

$$k_{b3} := \frac{I_{b3}}{L_{b3}} = 3.5125 \cdot \text{in}^3 \quad k_{c3} := \frac{I_{c3}}{h_{c3}} = 5.521 \cdot \text{in}^3$$

Number of columns $N_{\text{col}} := 10$

$$E := 29000 \text{ksi}$$

$$C_{\text{mod}} := 1$$

Period calculation

4.4.2.4 Period. The fundamental period of a building, in the direction under consideration, shall be calculated in accordance with Eq. (4-4).

$$T = C_t h_n^\beta \quad (4-4)$$

where

T = Fundamental period (s) in the direction under consideration;

C_t = 0.035 for moment-resisting frame systems of steel (Building Types S1 and S1a);

= 0.018 for moment-resisting frames of reinforced concrete (Building Type C1);

= 0.030 for eccentrically braced steel frames (Building Types S2 and S2a);

= 0.020 for all other framing systems;

h_n = Height (ft) above the base to the roof level;

$$C_t := 0.035 \quad h_{\text{tot}} := 52 \frac{\text{ft}}{\text{ft}} \quad \beta := 0.8$$

$$T_1 := C_t h_{\text{tot}}^\beta = 0.826$$

$$S_{x1} := 0.882$$

$$S_a := \frac{S_{x1}}{T_1} = 1.068$$

From R+C original calcs

RUTHERFORD & CHEKENE CONSULTING
a California corporation ENGINEERS
303 Second Street, Suite 800 North
San Francisco, California 94107
Tel: (415) 495-4222 Fax: (415) 546-7536

Project: EMS
Subject: H Block - South Bldg
Job No: 880175 By: HF
Date: 7-5-89 Sheet: 502

SEISMIC WEIGHTS

$$\begin{aligned}
 \text{Roof} &= 35.34' \times 72' \times 54 \text{ psf} &= 137.4^k \\
 &+ 687 \text{ plf} \times 215' &= 147.7 \\
 && \underline{W_R = 285.1^k} \\
 \\
 \text{Levels 3 \& 2} &= 35.34 \times 72 \times 96 \text{ psf} &= 244.3 \\
 &+ 9.67' \times 52' \times 96 &= 48.3 \\
 &+ 549 \text{ plf} \times 234' &= 128.5 \\
 \text{Bridge} &= 96 \text{ psf} \times 7' \times 27' &= 18.1^k \\
 && \underline{W_{3,2} = 439.2^k (N-S)} \\
 \\
 \text{Level 1} &= 35.34 \times 72 \times 96 &= 244.3 \\
 &+ 9.67 \times 52 \times 96 &= 48.3 \\
 &+ 790 \text{ plf} \times 234' &= 184.9 \\
 \text{Bridge} &= 96 \times 7 \times 27 &= 18.1^k \\
 && \underline{W_1 = 495.6^k (E-W) = 486.6^k (N-S)}
 \end{aligned}$$

$$\begin{aligned}
 W_{\text{base}} \rightarrow \text{North-South Direction} \\
 &= 285.1 + (439.2)2 + 486.6 = 1632^k
 \end{aligned}$$

$$\begin{aligned}
 W_{\text{base}} \rightarrow \text{East-West Direction} \\
 &= 285.1 + (439.2)2 + 495.6 = 1659^k
 \end{aligned}$$

$$w_1 := 495.6 \text{ kip} \quad w_2 := 439.2 \text{ kip} \quad w_3 := 439.2 \text{ kip} \quad w_4 := 285.1 \text{ kip}$$

$$W_{\text{total}} := w_1 + w_2 + w_3 + w_4 = 1659.1 \text{ kip}$$

Calculations of total shear and story shears

$$V_{\text{total}} := C_{\text{mod}} S_a W_{\text{total}} = 1.772 \times 10^3 \text{ kip}$$

$$h_1 := 16 \text{ ft} \quad h_2 := 28 \text{ ft} \quad h_3 := 40 \text{ ft} \quad h_4 := 52 \text{ ft}$$

4.4.2.2 Story Shear Forces. The pseudo seismic force calculated in accordance with Section 4.4.2.1 shall be distributed vertically in accordance with Eqs. (4-2a and 4-2b). For buildings six stories or fewer high, the value of k shall be permitted to be taken as 1.0.

$$F_x = \frac{w_x h_x^k}{\sum_{i=1}^n w_i h_i^k} V \quad (4-2a)$$

$$V_j = \sum_{x=j}^n F_x \quad (4-2b)$$

where

- V_j = Story shear at story level j ;
- n = Total number of stories above ground level;
- j = Number of story levels under consideration;
- W = Total seismic weight, per Section 4.4.2.1;
- V = Pseudo seismic force from Eq. (4-1);
- w_i = Portion of total building weight W located on or assigned to floor level i ;
- w_x = Portion of total building weight W located on or assigned to floor level x ;

- h_i = Height (ft) from the base to floor level i ;
- h_x = Height (ft) from the base to floor level x ; and
- $k = 1.0$ for $T \leq 0.5$ s and 2.0 for $T > 2.5$ s; linear interpolation shall be used for intermediate values of k .

For buildings with stiff or rigid diaphragms, the story shear forces shall be distributed to the lateral-force-resisting elements based on their relative rigidities. For buildings with flexible diaphragms (Types S1a, S2a, S5a, C2a, C3a, PC1, RM1, and URM), story shear shall be calculated separately for each line of lateral resistance.

$$k_{0.5} := 1 \quad k_{2.5} := 2$$

$$k_{\text{inter}} := 1 + (T_1 - 0.5) \cdot \frac{1}{2} = 1.163$$

$$\left(\frac{h_1}{\text{ft}}\right)^{k_{\text{inter}}} = 25.134 \quad \left(\frac{h_2}{\text{ft}}\right)^{k_{\text{inter}}} = 48.183 \quad \left(\frac{h_3}{\text{ft}}\right)^{k_{\text{inter}}} = 72.951 \quad \left(\frac{h_4}{\text{ft}}\right)^{k_{\text{inter}}} = 98.977$$

$$F_1 := \left[\frac{w_1 \cdot \text{ft} \cdot \left(\frac{h_1}{\text{ft}}\right)^{k_{\text{inter}}} \cdot V_{\text{total}}}{w_1 \cdot \text{ft} \cdot \left(\frac{h_1}{\text{ft}}\right)^{k_{\text{inter}}} + w_2 \cdot \text{ft} \cdot \left(\frac{h_2}{\text{ft}}\right)^{k_{\text{inter}}} + w_3 \cdot \text{ft} \cdot \left(\frac{h_3}{\text{ft}}\right)^{k_{\text{inter}}} + w_4 \cdot \text{ft} \cdot \left(\frac{h_4}{\text{ft}}\right)^{k_{\text{inter}}}} \right] = 235.131 \cdot \text{kip}$$

$$F_2 := \left[\frac{w_2 \cdot \text{ft} \cdot \left(\frac{h_2}{\text{ft}}\right)^{k_{\text{inter}}} \cdot V_{\text{total}}}{w_1 \cdot \text{ft} \cdot \left(\frac{h_1}{\text{ft}}\right)^{k_{\text{inter}}} + w_2 \cdot \text{ft} \cdot \left(\frac{h_2}{\text{ft}}\right)^{k_{\text{inter}}} + w_3 \cdot \text{ft} \cdot \left(\frac{h_3}{\text{ft}}\right)^{k_{\text{inter}}} + w_4 \cdot \text{ft} \cdot \left(\frac{h_4}{\text{ft}}\right)^{k_{\text{inter}}}} \right] = 399.456 \cdot \text{kip}$$

$$F_3 := \left[\frac{w_3 \cdot \text{ft} \cdot \left(\frac{h_3}{\text{ft}}\right)^{k_{\text{inter}}} \cdot V_{\text{total}}}{w_1 \cdot \text{ft} \cdot \left(\frac{h_1}{\text{ft}}\right)^{k_{\text{inter}}} + w_2 \cdot \text{ft} \cdot \left(\frac{h_2}{\text{ft}}\right)^{k_{\text{inter}}} + w_3 \cdot \text{ft} \cdot \left(\frac{h_3}{\text{ft}}\right)^{k_{\text{inter}}} + w_4 \cdot \text{ft} \cdot \left(\frac{h_4}{\text{ft}}\right)^{k_{\text{inter}}}} \right] = 604.789 \cdot \text{kip}$$

$$F_4 := \left[\frac{w_4 \cdot \text{ft} \cdot \left(\frac{h_4}{\text{ft}}\right)^{k_{\text{inter}}} \cdot V_{\text{total}}}{w_1 \cdot \text{ft} \cdot \left(\frac{h_1}{\text{ft}}\right)^{k_{\text{inter}}} + w_2 \cdot \text{ft} \cdot \left(\frac{h_2}{\text{ft}}\right)^{k_{\text{inter}}} + w_3 \cdot \text{ft} \cdot \left(\frac{h_3}{\text{ft}}\right)^{k_{\text{inter}}} + w_4 \cdot \text{ft} \cdot \left(\frac{h_4}{\text{ft}}\right)^{k_{\text{inter}}}} \right] = 532.651 \cdot \text{kip}$$

$$V_{\text{check}} := F_1 + F_2 + F_3 + F_4 = 1772 \cdot \text{kip}$$

$$V_{\text{total}} = 1772 \cdot \text{kip}$$

$$V_1 := F_1 + F_2 + F_3 + F_4 = 1.772 \times 10^3 \cdot \text{kip}$$

$$V_2 := F_2 + F_3 + F_4 = 1.537 \times 10^3 \cdot \text{kip}$$

$$V_3 := F_3 + F_4 = 1.137 \times 10^3 \cdot \text{kip}$$

$$V_4 := F_4 = 532.651 \cdot \text{kip}$$

$$V_{c1} := \frac{V_1}{N_{col}} = 177.203 \cdot \text{kip}$$

$$V_{c2} := \frac{V_2}{N_{col}} = 153.69 \cdot \text{kip}$$

$$V_{c3} := \frac{V_3}{N_{col}} = 113.744 \cdot \text{kip}$$

$$V_{c4} := \frac{V_4}{N_{col}} = 53.265 \cdot \text{kip}$$

Drift Calculations

$$D_{r1} := \left(\frac{k_{b1} + k_{c1}}{k_{b1} \cdot k_{c1}} \right) \cdot \left(\frac{h_{c1}}{12 \cdot E} \right) V_{c1} = 0.043 \quad \text{More than limit 0.03}$$

$$D_{r2} := \left(\frac{k_{b2} + k_{c2}}{k_{b2} \cdot k_{c2}} \right) \cdot \left(\frac{h_{c2}}{12 \cdot E} \right) V_{c2} = 0.03 \quad \text{More than limit 0.03}$$

$$D_{r3} := \left(\frac{k_{b3} + k_{c3}}{k_{b3} \cdot k_{c3}} \right) \cdot \left(\frac{h_{c3}}{12 \cdot E} \right) V_{c3} = 0.022 \quad \text{OK less than limit 0.03}$$

for Dr4 beams and columns are the same but the shear changes

$$D_{r4} := \left(\frac{k_{b3} + k_{c3}}{k_{b3} \cdot k_{c3}} \right) \cdot \left(\frac{h_{c3}}{12 \cdot E} \right) V_{c4} = 0.01 \quad \text{OK less than limit 0.03}$$



Rating form completed by:

RUTHERFORD + CHEKENE
ruthchek.com

Evaluator: CLP/EFA/WAL/BL

Date: 06/28/2019

Building A2 Drift check

Calculation of drift quick check according to ASCE 41-17

drift limit $D_{r\text{limit}} := 0.03$

$$D_r = \left(\frac{k_b + k_c}{k_b k_c} \right) \left(\frac{h}{12E} \right) V_c \quad (4-6)$$

where

D_r = Drift ratio: interstory displacement divided by story height;

k_b = I/L for the representative beam;

k_c = I/h for the representative column;

h = Story height (in.);

I = Moment of inertia (in.⁴);

L = Beam length from center-to-center of adjacent columns (in.);

E = Modulus of elasticity (kip/in.²); and

V_c = Shear in the column (kip).

$$I_{b1} := 843 \text{ in}^4 \quad L_{b1} := 20 \times 12 \text{ in} = 240 \cdot \text{in} \quad I_{c1} := 1240 \text{ in}^4 \quad h_{c1} := 16 \cdot 12 \text{ in} = 192 \cdot \text{in}$$

$$I_{b2} := 843 \text{ in}^4 \quad L_{b2} := 20 \times 12 \text{ in} = 240 \cdot \text{in} \quad I_{c2} := 795 \text{ in}^4 \quad h_{c2} := 12 \times 12 \text{ in} = 144 \cdot \text{in}$$

$$I_{b3} := 843 \text{ in}^4 \quad L_{b3} := 20 \times 12 \text{ in} = 240 \cdot \text{in} \quad I_{c3} := 795 \text{ in}^4 \quad h_{c3} := 12 \times 12 \text{ in} = 144 \cdot \text{in}$$

$$k_{b1} := \frac{I_{b1}}{L_{b1}} = 3.5125 \cdot \text{in}^3 \quad k_{c1} := \frac{I_{c1}}{h_{c1}} = 6.458 \cdot \text{in}^3$$

$$k_{b2} := \frac{I_{b2}}{L_{b2}} = 3.5125 \cdot \text{in}^3 \quad k_{c2} := \frac{I_{c2}}{h_{c2}} = 5.521 \cdot \text{in}^3$$

$$k_{b3} := \frac{I_{b3}}{L_{b3}} = 3.5125 \cdot \text{in}^3 \quad k_{c3} := \frac{I_{c3}}{h_{c3}} = 5.521 \cdot \text{in}^3$$

Number of columns $N_{\text{col}} := 10$

$$E := 29000 \text{ ksi}$$

$$C_{\text{mod}} := 1$$

Period calculation

4.4.2.4 Period. The fundamental period of a building, in the direction under consideration, shall be calculated in accordance with Eq. (4-4).

$$T = C_t h_n^\beta \quad (4-4)$$

where

T = Fundamental period (s) in the direction under consideration;

C_t = 0.035 for moment-resisting frame systems of steel (Building Types S1 and S1a);

= 0.018 for moment-resisting frames of reinforced concrete (Building Type C1);

= 0.030 for eccentrically braced steel frames (Building Types S2 and S2a);

= 0.020 for all other framing systems;

h_n = Height (ft) above the base to the roof level;

$$C_t := 0.035 \quad h_{\text{tot}} := 52 \frac{\text{ft}}{\text{ft}} \quad \beta := 0.8$$

$$T_1 := C_t h_{\text{tot}}^\beta = 0.826$$

$$S_{x1} := 0.882$$

$$S_a := \frac{S_{x1}}{T_1} = 1.068$$

From R+C original calcs

RUTHERFORD & CHEKENE | CONSULTING
a california corporation | ENGINEERS

303 Second Street, Suite 800 North
San Francisco, California 94107
Tel: (415) 495-4222 Fax: (415) 546-7536

Project EMS
Subject North Office Bldg
Job No. 980175 By HF
Date 7-10-89 Sheet NO 3

SEISMIC WEIGHTS

$$\begin{aligned} \text{Roof} &= 35.33' \times 82' \times 54 \text{ psf} &= 156.4 \text{ k} \\ &+ 235' \times 687 \text{ psf} &= 161.4 \\ \hline W_R &= 317.9 \text{ k} \end{aligned}$$

$$\begin{aligned} \text{Levels 2 \& 3} &= 35.33 \times 82 \times 96 &= 278.1 \\ &+ 9.67 \times 62 \times 96 &= 57.6 \\ &+ 254' \times 549 &= 139.4 \\ \hline W_{3,2} &= 475.1 \text{ k} \end{aligned}$$

$$\begin{aligned} \text{Level 1} &= 35.33 \times 82 \times 96 &= 278.1 \\ &+ 9.67 \times 62 \times 96 &= 57.6 \\ &+ 254 \times 790 &= 200.7 \\ \hline W_1 &= 536.4 \text{ k} \end{aligned}$$

$$W_{\text{Base}} = 317.9 + (475.1)2 + 536.4 = 1804.5 \text{ k}$$

$$w_1 := 536.4 \text{ kip} \quad w_2 := 475.1 \text{ kip} \quad w_3 := 475.1 \text{ kip} \quad w_4 := 317.9 \text{ kip}$$

$$W_{\text{total}} := w_1 + w_2 + w_3 + w_4 = 1804.5 \text{ kip}$$

Calculations of total shear and story shears

$$V_{\text{total}} := C_{\text{mod}} S_a \cdot W_{\text{total}} = 1.927 \times 10^3 \cdot \text{kip}$$

$$h_1 := 16 \text{ ft} \quad h_2 := 28 \text{ ft} \quad h_3 := 40 \text{ ft} \quad h_4 := 52 \text{ ft}$$

4.4.2.2 Story Shear Forces. The pseudo seismic force calculated in accordance with Section 4.4.2.1 shall be distributed vertically in accordance with Eqs. (4-2a and 4-2b). For buildings six stories or fewer high, the value of k shall be permitted to be taken as 1.0.

$$F_x = \frac{w_x h_x^k}{\sum_{i=1}^n w_i h_i^k} V \quad (4-2a)$$

$$V_j = \sum_{x=j}^n F_x \quad (4-2b)$$

where

- V_j = Story shear at story level j ;
- n = Total number of stories above ground level;
- j = Number of story levels under consideration;
- W = Total seismic weight, per Section 4.4.2.1;
- V = Pseudo seismic force from Eq. (4-1);
- w_i = Portion of total building weight W located on or assigned to floor level i ;
- w_x = Portion of total building weight W located on or assigned to floor level x ;

- h_i = Height (ft) from the base to floor level i ;
- h_x = Height (ft) from the base to floor level x ; and
- k = 1.0 for $T \leq 0.5$ s and 2.0 for $T > 2.5$ s; linear interpolation shall be used for intermediate values of k .

For buildings with stiff or rigid diaphragms, the story shear forces shall be distributed to the lateral-force-resisting elements based on their relative rigidities. For buildings with flexible diaphragms (Types S1a, S2a, S5a, C2a, C3a, PC1, RM1, and URM), story shear shall be calculated separately for each line of lateral resistance.

$$k_{0.5} := 1 \quad k_{2.5} := 2$$

$$k_{\text{inter}} := 1 + (T_1 - 0.5) \cdot \frac{1}{2} = 1.163$$

$$\left(\frac{h_1}{\text{ft}}\right)^{k_{\text{inter}}} = 25.134 \quad \left(\frac{h_2}{\text{ft}}\right)^{k_{\text{inter}}} = 48.183 \quad \left(\frac{h_3}{\text{ft}}\right)^{k_{\text{inter}}} = 72.951 \quad \left(\frac{h_4}{\text{ft}}\right)^{k_{\text{inter}}} = 98.977$$

$$F_1 := \left[\begin{array}{c} w_1 \cdot \text{ft} \cdot \left(\frac{h_1}{\text{ft}}\right)^{k_{\text{inter}}} \cdot V_{\text{total}} \\ \left[w_1 \cdot \text{ft} \cdot \left(\frac{h_1}{\text{ft}}\right)^{k_{\text{inter}}} + w_2 \cdot \text{ft} \cdot \left(\frac{h_2}{\text{ft}}\right)^{k_{\text{inter}}} + w_3 \cdot \text{ft} \cdot \left(\frac{h_3}{\text{ft}}\right)^{k_{\text{inter}}} + w_4 \cdot \text{ft} \cdot \left(\frac{h_4}{\text{ft}}\right)^{k_{\text{inter}}} \right] \end{array} \right] = 253.511 \cdot \text{kip}$$

$$F_2 := \left[\begin{array}{c} w_2 \cdot \text{ft} \cdot \left(\frac{h_2}{\text{ft}}\right)^{k_{\text{inter}}} \cdot V_{\text{total}} \\ \left[w_1 \cdot \text{ft} \cdot \left(\frac{h_1}{\text{ft}}\right)^{k_{\text{inter}}} + w_2 \cdot \text{ft} \cdot \left(\frac{h_2}{\text{ft}}\right)^{k_{\text{inter}}} + w_3 \cdot \text{ft} \cdot \left(\frac{h_3}{\text{ft}}\right)^{k_{\text{inter}}} + w_4 \cdot \text{ft} \cdot \left(\frac{h_4}{\text{ft}}\right)^{k_{\text{inter}}} \right] \end{array} \right] = 430.449 \cdot \text{kip}$$

$$F_3 := \left[\begin{array}{c} w_3 \cdot \text{ft} \cdot \left(\frac{h_3}{\text{ft}}\right)^{k_{\text{inter}}} \cdot V_{\text{total}} \\ \left[w_1 \cdot \text{ft} \cdot \left(\frac{h_1}{\text{ft}}\right)^{k_{\text{inter}}} + w_2 \cdot \text{ft} \cdot \left(\frac{h_2}{\text{ft}}\right)^{k_{\text{inter}}} + w_3 \cdot \text{ft} \cdot \left(\frac{h_3}{\text{ft}}\right)^{k_{\text{inter}}} + w_4 \cdot \text{ft} \cdot \left(\frac{h_4}{\text{ft}}\right)^{k_{\text{inter}}} \right] \end{array} \right] = 651.713 \cdot \text{kip}$$

$$F_4 := \left[\begin{array}{c} w_4 \cdot \text{ft} \cdot \left(\frac{h_4}{\text{ft}}\right)^{k_{\text{inter}}} \cdot V_{\text{total}} \\ \left[w_1 \cdot \text{ft} \cdot \left(\frac{h_1}{\text{ft}}\right)^{k_{\text{inter}}} + w_2 \cdot \text{ft} \cdot \left(\frac{h_2}{\text{ft}}\right)^{k_{\text{inter}}} + w_3 \cdot \text{ft} \cdot \left(\frac{h_3}{\text{ft}}\right)^{k_{\text{inter}}} + w_4 \cdot \text{ft} \cdot \left(\frac{h_4}{\text{ft}}\right)^{k_{\text{inter}}} \right] \end{array} \right] = 591.652 \cdot \text{kip}$$

$$V_{\text{check}} := F_1 + F_2 + F_3 + F_4 = 1927.3 \cdot \text{kip}$$

$$V_{\text{total}} = 1927.3 \cdot \text{kip}$$

$$V_1 := F_1 + F_2 + F_3 + F_4 = 1.927 \times 10^3 \cdot \text{kip}$$

$$V_2 := F_2 + F_3 + F_4 = 1.674 \times 10^3 \cdot \text{kip}$$

$$V_3 := F_3 + F_4 = 1.243 \times 10^3 \cdot \text{kip}$$

$$V_4 := F_4 = 591.652 \cdot \text{kip}$$

$$V_{c1} := \frac{V_1}{N_{col}} = 192.732 \cdot \text{kip}$$

$$V_{c2} := \frac{V_2}{N_{col}} = 167.381 \cdot \text{kip}$$

$$V_{c3} := \frac{V_3}{N_{col}} = 124.336 \cdot \text{kip}$$

$$V_{c4} := \frac{V_4}{N_{col}} = 59.165 \cdot \text{kip}$$

Drift Calculations

$$D_{r1} := \left(\frac{k_{b1} + k_{c1}}{k_{b1} \cdot k_{c1}} \right) \cdot \left(\frac{h_{c1}}{12 \cdot E} \right) \cdot V_{c1} = 0.047 \quad \text{More than limit 0.03}$$

$$D_{r2} := \left(\frac{k_{b2} + k_{c2}}{k_{b2} \cdot k_{c2}} \right) \cdot \left(\frac{h_{c2}}{12 \cdot E} \right) \cdot V_{c2} = 0.032 \quad \text{More than limit 0.03}$$

$$D_{r3} := \left(\frac{k_{b3} + k_{c3}}{k_{b3} \cdot k_{c3}} \right) \cdot \left(\frac{h_{c3}}{12 \cdot E} \right) \cdot V_{c3} = 0.024 \quad \text{OK less than limit 0.03}$$

for Dr4 beams and columns are the same but the shear changes

$$D_{r4} := \left(\frac{k_{b3} + k_{c3}}{k_{b3} \cdot k_{c3}} \right) \cdot \left(\frac{h_{c3}}{12 \cdot E} \right) \cdot V_{c4} = 0.011 \quad \text{OK less than limit 0.03}$$



Rating form completed by:

RUTHERFORD + CHEKENE
ruthchek.com

Evaluator: CLP/EFA/WAL/BL

Date: 06/28/2019

Lobby Drift check

Calculation of deflection quick check according to ASCE 41-17

drift limit $D_{r\text{limit}} := 0.03$

$$D_r = \left(\frac{k_b + k_c}{k_b k_c} \right) \left(\frac{h}{12E} \right) V_c \quad (4-6)$$

where

D_r = Drift ratio: interstory displacement divided by story height;

k_b = I/L for the representative beam;

k_c = I/h for the representative column;

h = Story height (in.);

I = Moment of inertia (in.⁴);

L = Beam length from center-to-center of adjacent columns (in.);

E = Modulus of elasticity (kip/in.²); and

V_c = Shear in the column (kip).

$$I_{b1} := 843 \text{ in}^4 \quad L_{b1} := 20 \times 12 \text{ in} = 240 \cdot \text{in} \quad I_{c1} := 1240 \text{ in}^4 \quad h_{c1} := 16 \cdot 12 \text{ in} = 192 \cdot \text{in}$$

$$I_{b2} := 843 \text{ in}^4 \quad L_{b2} := 20 \times 12 \text{ in} = 240 \cdot \text{in} \quad I_{c2} := 795 \text{ in}^4 \quad h_{c2} := 12 \times 12 \text{ in} = 144 \cdot \text{in}$$

$$I_{b3} := 843 \text{ in}^4 \quad L_{b3} := 20 \times 12 \text{ in} = 240 \cdot \text{in} \quad I_{c3} := 795 \text{ in}^4 \quad h_{c3} := 12 \times 12 \text{ in} = 144 \cdot \text{in}$$

$$k_{b1} := \frac{I_{b1}}{L_{b1}} = 3.5125 \cdot \text{in}^3 \quad k_{c1} := \frac{I_{c1}}{h_{c1}} = 6.458 \cdot \text{in}^3$$

$$k_{b2} := \frac{I_{b2}}{L_{b2}} = 3.5125 \cdot \text{in}^3 \quad k_{c2} := \frac{I_{c2}}{h_{c2}} = 5.521 \cdot \text{in}^3$$

$$k_{b3} := \frac{I_{b3}}{L_{b3}} = 3.5125 \cdot \text{in}^3 \quad k_{c3} := \frac{I_{c3}}{h_{c3}} = 5.521 \cdot \text{in}^3$$

Number of columns $N_{\text{col}} := 10$

$$E := 29000 \text{ksi}$$

$$C_{\text{mod}} := 1$$

Period calculation

4.4.2.4 Period. The fundamental period of a building, in the direction under consideration, shall be calculated in accordance with Eq. (4-4).

$$T = C_t h_n^\beta \quad (4-4)$$

where

T = Fundamental period (s) in the direction under consideration;

C_t = 0.035 for moment-resisting frame systems of steel (Building Types S1 and S1a);

= 0.018 for moment-resisting frames of reinforced concrete (Building Type C1);

= 0.030 for eccentrically braced steel frames (Building Types S2 and S2a);

= 0.020 for all other framing systems;

h_n = Height (ft) above the base to the roof level;

$$C_t := 0.035 \quad h_{\text{tot}} := 52 \frac{\text{ft}}{\text{ft}} \quad \beta := 0.8$$

$$T_1 := C_t h_{\text{tot}}^\beta = 0.826$$

$$S_{x1} := 0.882$$

$$S_a := \frac{S_{x1}}{T_1} = 1.068$$

From R+C original calcs

RUTHERFORD & CHEKENE CONSULTING ENGINEERS
a california corporation
305 Second Street, Suite 800 North
San Francisco, California 94107
Tel: (415) 495-4222 Fax: (415) 546-7536

Project: EMS
Subject: Office Lobby
Job No: 890175 By: HF
Date: 7-15-89 Sheet: 1 of 1

SEISMIC LOADING

This Bldg is irregular, but since it is less than 5 stories, and less than 65' in height, it may be analyzed by the static force method, as defined in Section 2312 of the 1989 UBC.

$$V = \frac{ZICW}{R_w} \quad z = .4, \quad I = 1.0, \quad R_w = 12$$

$$T = .035(h_n)^{3/4} = .035(54)^{3/4} = .697 \text{ sec.}$$

$$S = 1.0$$

$$C = 1.25(1.0) / (.697)^{1/4} = 1.59$$

$$C/R_w = .133 > .08 \text{ v.o.k.}$$

$$V = (.4)(1.0)(.133)W$$

$$V = .053W$$

$$V_{base} = .053(693^k) = 37^k$$

Level	w _i	h _i	w _i h _i	w _i h _i / Σw _i h _i	V _i	ΣV _i
Roof	283 ^k	52'	14,716 ^{ks}	.56	20.8 ^k	20.8 ^k
L3	125	40'	5000	.19	7.1	27.8
L2	161	28'	4508	.17	6.4	34.2
L1	125	16'	2000	.08	2.8	37.0
			Σ = 26224 ^{ks}			

Based on analyses of the Atrium and North and South Office Buildings, it can be assumed that the actual "T" for the office lobby is large enough to reduce the required seismic load to .8 x load found by Method A

$$\therefore V = .8(.053)W = .042W$$

$$\text{EQUIVALENT "T" } = .99 \text{ sec} \rightarrow 1.00 \text{ sec.}$$

(to produce .042)

$$w_1 := 125 \text{ kip}$$

$$w_2 := 161 \text{ kip}$$

$$w_3 := 125 \text{ kip}$$

$$w_4 := 283 \text{ kip}$$

$$W_{\text{total}} := w_1 + w_2 + w_3 + w_4 = 694 \text{ kip}$$

Calculations of total shear and story shears

$$V_{\text{total}} := C_{\text{mod}} S_a \cdot W_{\text{total}} = 741.237 \text{ kip}$$

$$h_1 := 16 \text{ ft}$$

$$h_2 := 28 \text{ ft}$$

$$h_3 := 40 \text{ ft}$$

$$h_4 := 52 \text{ ft}$$

4.4.2.2 Story Shear Forces. The pseudo seismic force calculated in accordance with Section 4.4.2.1 shall be distributed vertically in accordance with Eqs. (4-2a and 4-2b). For buildings six stories or fewer high, the value of k shall be permitted to be taken as 1.0.

$$F_x = \frac{w_x h_x^k}{\sum_{i=1}^n w_i h_i^k} V \quad (4-2a)$$

$$V_j = \sum_{x=j}^n F_x \quad (4-2b)$$

where

- V_j = Story shear at story level j ;
- n = Total number of stories above ground level;
- j = Number of story levels under consideration;
- W = Total seismic weight, per Section 4.4.2.1;
- V = Pseudo seismic force from Eq. (4-1);
- w_i = Portion of total building weight W located on or assigned to floor level i ;
- w_x = Portion of total building weight W located on or assigned to floor level x ;

- h_i = Height (ft) from the base to floor level i ;
- h_x = Height (ft) from the base to floor level x ; and
- $k = 1.0$ for $T \leq 0.5$ s and 2.0 for $T > 2.5$ s; linear interpolation shall be used for intermediate values of k .

For buildings with stiff or rigid diaphragms, the story shear forces shall be distributed to the lateral-force-resisting elements based on their relative rigidities. For buildings with flexible diaphragms (Types S1a, S2a, S5a, C2a, C3a, PC1, RM1, and URM), story shear shall be calculated separately for each line of lateral resistance.

$$k_{0.5} := 1 \quad k_{2.5} := 2$$

$$k_{\text{inter}} := 1 + (T_1 - 0.5) \cdot \frac{1}{2} = 1.163$$

$$\left(\frac{h_1}{\text{ft}}\right)^{k_{\text{inter}}} = 25.134 \quad \left(\frac{h_2}{\text{ft}}\right)^{k_{\text{inter}}} = 48.183 \quad \left(\frac{h_3}{\text{ft}}\right)^{k_{\text{inter}}} = 72.951 \quad \left(\frac{h_4}{\text{ft}}\right)^{k_{\text{inter}}} = 98.977$$

$$F_1 := \left[\frac{w_1 \cdot \text{ft} \cdot \left(\frac{h_1}{\text{ft}}\right)^{k_{\text{inter}}} \cdot V_{\text{total}}}{w_1 \cdot \text{ft} \cdot \left(\frac{h_1}{\text{ft}}\right)^{k_{\text{inter}}} + w_2 \cdot \text{ft} \cdot \left(\frac{h_2}{\text{ft}}\right)^{k_{\text{inter}}} + w_3 \cdot \text{ft} \cdot \left(\frac{h_3}{\text{ft}}\right)^{k_{\text{inter}}} + w_4 \cdot \text{ft} \cdot \left(\frac{h_4}{\text{ft}}\right)^{k_{\text{inter}}}} \right] = 48.488 \cdot \text{kip}$$

$$F_2 := \left[\frac{w_2 \cdot \text{ft} \cdot \left(\frac{h_2}{\text{ft}}\right)^{k_{\text{inter}}} \cdot V_{\text{total}}}{w_1 \cdot \text{ft} \cdot \left(\frac{h_1}{\text{ft}}\right)^{k_{\text{inter}}} + w_2 \cdot \text{ft} \cdot \left(\frac{h_2}{\text{ft}}\right)^{k_{\text{inter}}} + w_3 \cdot \text{ft} \cdot \left(\frac{h_3}{\text{ft}}\right)^{k_{\text{inter}}} + w_4 \cdot \text{ft} \cdot \left(\frac{h_4}{\text{ft}}\right)^{k_{\text{inter}}}} \right] = 119.723 \cdot \text{kip}$$

$$F_3 := \left[\frac{w_3 \cdot \text{ft} \cdot \left(\frac{h_3}{\text{ft}}\right)^{k_{\text{inter}}} \cdot V_{\text{total}}}{w_1 \cdot \text{ft} \cdot \left(\frac{h_1}{\text{ft}}\right)^{k_{\text{inter}}} + w_2 \cdot \text{ft} \cdot \left(\frac{h_2}{\text{ft}}\right)^{k_{\text{inter}}} + w_3 \cdot \text{ft} \cdot \left(\frac{h_3}{\text{ft}}\right)^{k_{\text{inter}}} + w_4 \cdot \text{ft} \cdot \left(\frac{h_4}{\text{ft}}\right)^{k_{\text{inter}}}} \right] = 140.733 \cdot \text{kip}$$

$$F_4 := \left[\frac{w_4 \cdot \text{ft} \cdot \left(\frac{h_4}{\text{ft}}\right)^{k_{\text{inter}}} \cdot V_{\text{total}}}{w_1 \cdot \text{ft} \cdot \left(\frac{h_1}{\text{ft}}\right)^{k_{\text{inter}}} + w_2 \cdot \text{ft} \cdot \left(\frac{h_2}{\text{ft}}\right)^{k_{\text{inter}}} + w_3 \cdot \text{ft} \cdot \left(\frac{h_3}{\text{ft}}\right)^{k_{\text{inter}}} + w_4 \cdot \text{ft} \cdot \left(\frac{h_4}{\text{ft}}\right)^{k_{\text{inter}}}} \right] = 432.293 \cdot \text{kip}$$

$$V_{\text{check}} := F_1 + F_2 + F_3 + F_4 = 741.2 \cdot \text{kip}$$

$$V_{\text{total}} = 741.2 \cdot \text{kip}$$

$$V_1 := F_1 + F_2 + F_3 + F_4 = 1.927 \times 10^3 \cdot \text{kip}$$

$$V_2 := F_2 + F_3 + F_4 = 1.674 \times 10^3 \cdot \text{kip}$$

$$V_3 := F_3 + F_4 = 1.243 \times 10^3 \cdot \text{kip}$$

$$V_4 := F_4 = 591.652 \cdot \text{kip}$$

$$V_{c1} := \frac{V_1}{N_{col}} = 192.732 \cdot \text{kip}$$

$$V_{c2} := \frac{V_2}{N_{col}} = 167.381 \cdot \text{kip}$$

$$V_{c3} := \frac{V_3}{N_{col}} = 124.336 \cdot \text{kip}$$

$$V_{c4} := \frac{V_4}{N_{col}} = 59.165 \cdot \text{kip}$$

Drift Calculations

$$D_{r1} := \left(\frac{k_{b1} + k_{c1}}{k_{b1} \cdot k_{c1}} \right) \cdot \left(\frac{h_{c1}}{12 \cdot E} \right) \cdot V_{c1} = 0.047 \quad \text{More than limit 0.03}$$

$$D_{r2} := \left(\frac{k_{b2} + k_{c2}}{k_{b2} \cdot k_{c2}} \right) \cdot \left(\frac{h_{c2}}{12 \cdot E} \right) \cdot V_{c2} = 0.032 \quad \text{More than limit 0.03}$$

$$D_{r3} := \left(\frac{k_{b3} + k_{c3}}{k_{b3} \cdot k_{c3}} \right) \cdot \left(\frac{h_{c3}}{12 \cdot E} \right) \cdot V_{c3} = 0.024 \quad \text{OK less than limit 0.03}$$

for Dr4 beams and columns are the same but the shear changes

$$D_{r4} := \left(\frac{k_{b3} + k_{c3}}{k_{b3} \cdot k_{c3}} \right) \cdot \left(\frac{h_{c3}}{12 \cdot E} \right) \cdot V_{c4} = 0.011 \quad \text{OK less than limit 0.03}$$



Rating form completed by:

RUTHERFORD + CHEKENE
ruthchek.com

Evaluator: CLP/EFA/WAL/BL

Date: 06/28/2019

Axial Force check building A1 A2

Axia Force Calc Building A1

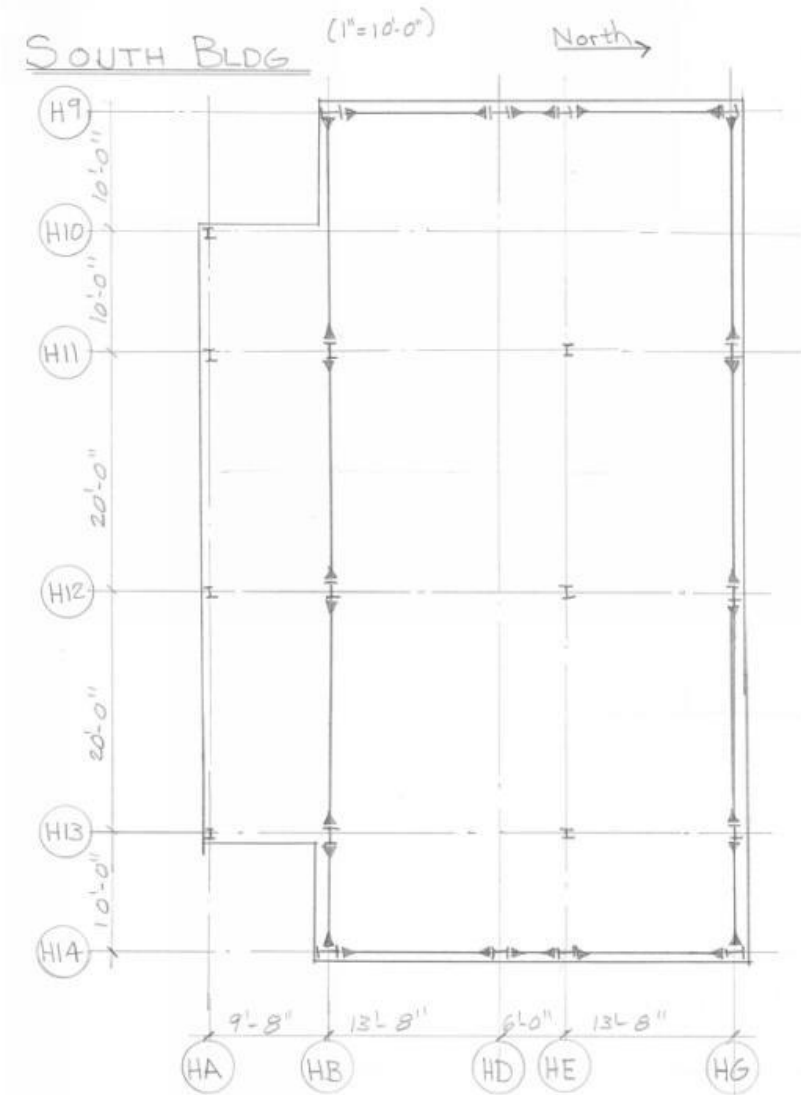

Check Top column on right

$$A_{trib} := \frac{13.66ft \cdot 20ft}{4} = 68.3 \cdot ft^2$$

$$A_{roof} := 2389ft^2$$

$$A_{3rd} := 2952ft^2$$

$$A_{2nd} := 2952ft^2$$

$$A_{1st} := 2952ft^2$$

$$W_{roof} := 285.1kip$$

$$W_{3rd} := 439.2kip$$

$$W_{2nd} := 439.2kip$$

$$W_{1st} := 495.6kip$$

Building A1		
Floor	Weight (kip)	Total weight (kip)
roof	285.1	
3	439.2	
2	439.2	
1	495.6	
		1659.1

$$w_{\text{roof}} := \frac{W_{\text{roof}}}{A_{\text{roof}}} = 119.339 \cdot \text{psf}$$

$$w_{3\text{rd}} := \frac{W_{3\text{rd}}}{A_{3\text{rd}}} = 148.78 \cdot \text{psf}$$

$$w_{2\text{nd}} := \frac{W_{2\text{nd}}}{A_{2\text{nd}}} = 148.78 \cdot \text{psf}$$

$$w_{1\text{st}} := \frac{W_{1\text{st}}}{A_{1\text{st}}} = 167.886 \cdot \text{psf}$$

Sum of the weight for all floors

$$w_{\text{all}} := w_{\text{roof}} + w_{3\text{rd}} + w_{2\text{nd}} + w_{1\text{st}} = 584.786 \cdot \text{psf}$$

$$\text{Axial}_{\text{load}} := w_{\text{all}} \cdot A_{\text{trib}} = 39.941 \cdot \text{kip}$$

Member W12x96 $A_s := 28.2 \text{in}^2$ $F_y := 36 \text{ksi}$

$$\text{Axial}_{\text{stress}} := \frac{\text{Axial}_{\text{load}}}{A_s} = 1.416 \cdot \text{ksi}$$

$$\text{Limit} := 0.1F_y = 3.6 \cdot \text{ksi}$$

The Column Axial stress complies less than $0.1F_y$

Building A2		
Floor	Weight (kip)	Total weight (kip)
roof	317.9	
3	475.1	
2	475.1	
1	536.4	
		1804.5

$$w_{\text{roof}} := \frac{W_{\text{roof}}}{A_{\text{roof}}} = 133.068 \cdot \text{psf}$$

$$w_{3\text{rd}} := \frac{W_{3\text{rd}}}{A_{3\text{rd}}} = 160.942 \cdot \text{psf}$$

$$w_{2\text{nd}} := \frac{W_{2\text{nd}}}{A_{2\text{nd}}} = 160.942 \cdot \text{psf}$$

$$w_{1\text{st}} := \frac{W_{1\text{st}}}{A_{1\text{st}}} = 181.707 \cdot \text{psf}$$

Sum of the weight for all foors

$$w_{\text{all}} := w_{\text{roof}} + w_{3\text{rd}} + w_{2\text{nd}} + w_{1\text{st}} = 636.659 \cdot \text{psf}$$

$$\text{Axial}_{\text{load}} := w_{\text{all}} \cdot A_{\text{trib}} = 43.484 \text{ kip}$$

Member W12x96 $A_s := 28.2 \text{ in}^2$ $F_y := 36 \text{ ksi}$

$$\text{Axial}_{\text{stress}} := \frac{\text{Axial}_{\text{load}}}{A_s} = 1.542 \cdot \text{ksi}$$

Limit := $0.1F_y = 3.6 \text{ ksi}$ The Column Axial stress complies less than $0.1F_y$

Axia Force Calc Bulding A2

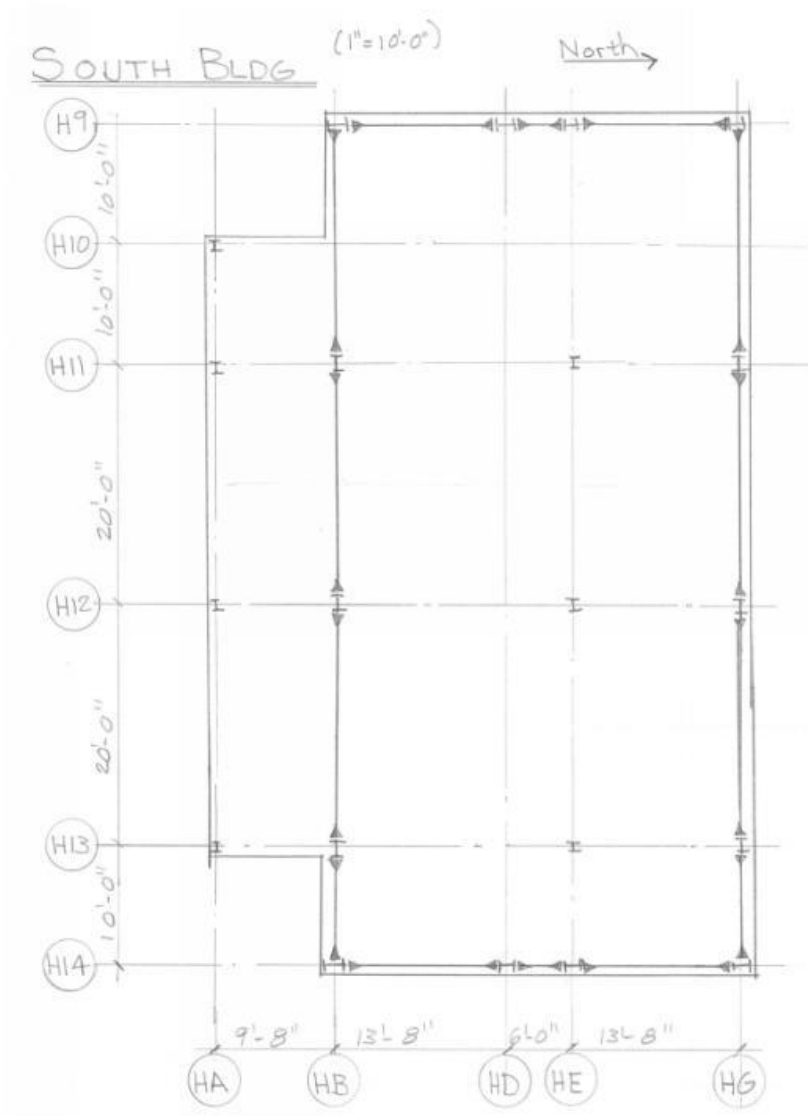

Check Top column on right

$$A_{trib} := \frac{13.66\text{ft} \cdot 20\text{ft}}{4} = 68.3 \cdot \text{ft}^2$$

$$A_{roof} := 2389\text{ft}^2$$

$$A_{3rd} := 2952\text{ft}^2$$

$$A_{2nd} := 2952\text{ft}^2$$

$$A_{1st} := 2952\text{ft}^2$$

$$W_{roof} := 317.9\text{kip}$$

$$W_{3rd} := 475.1\text{kip}$$

$$W_{2nd} := 475.1\text{kip}$$

$$W_{1st} := 536.4\text{kip}$$



Rating form completed by:

RUTHERFORD + CHEKENE
ruthchek.com

Evaluator: CLP/EFA/WAL/BL

Date: 06/28/2019



Rating form completed by:

RUTHERFORD + CHEKENE
ruthchek.com

Evaluator: CLP/EFA/WAL/BL

Date: 06/28/2019

Building A2 Flexural stress check and strong columns weak girder check

Column flexural stress check

▪ Flexural stress check ¶

4.4.3.9 Flexural Stress in Columns and Beams of Steel Moment Frames. The average flexural stress in the columns and beams of steel frames at each level shall be computed in accordance with Eq. (4-14).

$$f_j^{avg} = V_j \frac{1}{M_s} \left(\frac{n_c}{n_c - n_f} \right) \left(\frac{h}{2} \right) \frac{1}{Z} \quad (4-14)$$

where

- n_c = Total number of frame columns at the level, j , under consideration.
- n_f = Total number of frames in the direction of loading at the level, j , under consideration.
- V_j = Story shear computed in accordance with Section 4.4.2.2.
- h = Story height (in.).
- Z = For columns, the sum of the plastic section moduli of all the frame columns at the level under consideration. For beams, it is the sum of the plastic section moduli of all the frame beams with moment-resisting connections. If a beam has moment-resisting connections at both ends, then the contribution of that beam to the sum is twice the plastic section modulus of that beam (in³).
- M_s = System modification factor; M_s shall be taken as equal to 9.0 for buildings being evaluated to the Collapse Prevention Performance Level, equal to 6.0 for buildings being evaluated to the Life Safety Performance Level, and equal to 2.5 for buildings being evaluated to the Immediate Occupancy Performance Level for columns and beams satisfying the checklist items for compactness and column axial stress. If the columns or beams do not satisfy the checklist statements for compactness and column axial stress for the Immediate Occupancy Performance Level, then this item must be marked "Noncompliant".

From Calculation of deflections for Building A2 V1st=1927kip

$$V_j := 1927 \text{ kip} \quad M_s := 9 \quad n_f := 2 \quad n_c := 10 \quad h := 16 \text{ ft}$$

$$W12 \times 96 \quad Z_{12 \times 96} := 147 \text{ in}^3$$

$$W14 \times 109 \quad Z_{14 \times 109} := 192 \text{ in}^3$$

$$Z_{total} := 4 \cdot Z_{12 \times 96} + 6 \cdot Z_{14 \times 109} = 1740 \text{ in}^3$$

$$f_{javg} := \frac{V_j}{M_s} \left(\frac{n_c}{n_c - n_f} \right) \left(\frac{h}{2} \right) \frac{1}{Z_{total}} = 14.8 \text{ ksi} \quad F_y := 36 \text{ ksi}$$

Average flexural stress is 17.5ksi less than 36ksi complies

Simplified check of strong column weak girder

From AISC 341-10

$$\frac{\Sigma M_{pc}^*}{\Sigma M_{pb}^*} > 1.0 \quad (E3-1)$$

Where

is permitted to determine ΣM_{pc}^* as follows:

$$\Sigma M_{pc}^* = \Sigma Z_c (F_{yc} - P_{uc}/A_g) \quad (\text{LRFD}) \quad (E3-2a)$$

determine ΣM_{pb}^* as follows:

$$\Sigma M_{pb}^* = \Sigma (1.1 R_y F_{yb} Z_b + M_{uv}) \quad (\text{LRFD}) \quad (E3-3a)$$

To do a simple analysis since the P_{uc}/A_g is very small for the columns as per R+C original calcs we will use $P_{uc}/A_g = 0.14 F_y$

We will not use the M_{uv}

$$\text{Beam } 21 \times 44 \quad Z_{21 \times 44} := 95.4 \text{ in}^3$$

$$\text{Column } 14 \times 74 \quad Z_{14 \times 74} := 126 \text{ in}^3$$

$$F_y := 36 \text{ ksi}$$

$$\text{Sum } M_{pc} := 2 \cdot Z_{14 \times 74} \cdot (F_y - 0.14 F_y) = 7.802 \times 10^3 \cdot \text{in} \cdot \text{kip}$$

$$R_y := 1.5$$

$$\text{Sum } M_{pb} := 2 \cdot 1.1 \cdot R_y \cdot F_y \cdot Z_{21 \times 44} = 1.133 \times 10^4 \cdot \text{in} \cdot \text{kip}$$

$$\text{RatioColBeam} := \frac{\text{Sum } M_{pc}}{\text{Sum } M_{pb}} = 0.688 \quad \text{Not strong column weak girder.}$$