



Rating form completed by
Jack Wegleitner, Jay Yin

Text in *green* is to be part of UC Santa Cruz building database and may be part of UCOP database

DATE: 2019-06-30

UC Santa Cruz building seismic ratings Astronomy Shop A

CAAN #7171

624 Red Hill Road, Santa Cruz CA 95064

UCSC Campus: Main Campus



6/28/19



Rating summary	Entry	Notes
UC Seismic Performance Level (rating)	V (Poor)	
Rating basis	Tier 1	ASCE 41-17 ¹
Date of rating	2019	
Recommended UC Santa Cruz priority category for retrofit	Priority A	Priority A=Retrofit ASAP Priority B=Retrofit at next permit application
Ballpark total construction cost to retrofit to IV rating ²	Medium (~\$50/sf-\$200/sf)	See recommendations on further evaluation and retrofit.
Is 2018-2019 rating required by UCOP?	Yes	
Further evaluation recommended?	Yes	Remove finishes to survey bracing. Take measurements of moment frame members

¹ We translate this Tier 1 evaluation to a Seismic Performance Level rating using professional judgment. Noncompliant items in the Tier 1 evaluation do not automatically put a building into a particular rating category, but we evaluate such items along with the combination of building features and potential deficiencies, focused on the potential for collapse or serious damage to the gravity supporting structure that may threaten occupant safety. See Section III B of the UC Seismic Policy and Method B of Section 321 of the 2016 California Existing Building Code.

² Per Section 3.A.4.i of the Seismic Program Guidebook, the cost includes all construction cost necessitated by the seismic retrofit, including restoration of finishes and any triggered work on utilities or accessibility. It does not include soft costs such as design fees or campus costs. The cost is in 2019 dollars.

Building information used in this evaluation

- Architectural drawings "Surge Buildings for Lick Observatory Shops" as-built dated 13 May 1966
- Addition Drawings "Lick Shop Building "A" Expansion" as-built dated 12 Jan 1988
- University of California building database information, "Astronomy Shop A," provided by Jose Sanchez (UCSC) on 2018-11-20.

Additional building information known to exist

None

Scope for completing this form

Reviewed structural drawings and performed a site visit to confirm as-builts. Evaluated non-structural life-safety hazards during site visit. Completed an ASCE41-17 Tier 1 evaluation

Brief description of structure

The Lick Observatory Shop A is on UCSC's main campus. The building was designed and built in 1966. Original shop drawings for the portal frame structures are not available so the original designer is unknown. The building serves as a machine shop for the Lick observatory.

The building is a single story tilt up portal frame with lightweight metal panels serving as the roof and exterior walls. There are some tension only braces in the longitudinal direction. It appears that some of the braces were removed or not installed based on the site visit. Information on the foundation is not available. There appears to be a slab on grade based on the site visit.

Two additional structure were added in 1988. Both structures are also prefabricated portal frames. A small storage shed was added to the south of the structure. A large, tall manufacturing space was added to the east of the structure. Erection drawings are available for these structures are consistent with site visit observations. The drawings and site visit did not indicate that the additions are tied to the original structure. The portal frames in the addition to the east of the original structure are oriented perpendicular to the portal frames in the original structure. There is not a large gap between the two structures, so pounding is a concern at this joint.

Identification of levels: There is a ground floor in all the structures. There is a structurally detached mezzanine in the eastern addition. (Ground Floor)

Foundation system: No information is available on the foundation system. There is a slab on grade based on the site visit. It is unknown what the foundation looks like under the portal frame columns. The foundation for the additions is spread footings under the portal frame columns and grade beams around the perimeter of the structure.

Structural system for vertical (gravity) load: The vertical loads are supported by a lightweight steel deck roof supported on roof joists that span to portal frames.

Structural system for lateral forces: The lateral system in the building is a moment frame in the transverse direction. In the longitudinal direction, it is tension only cable bracing.

Brief description of seismic deficiencies and expected seismic performance including mechanism of nonlinear response and structural behavior modes

The minimal bracing in the longitudinal direction is not expected to perform well during an earthquake. The frame moment connection will perform better than the longitudinal bracing but still do not have enough capacity based on the quick checks. The three structures may also pound which will introduce additional forces into the already deficient lateral system.

Structural deficiency	Affects rating?	Structural deficiency	Affects rating?
Lateral system stress check (wall shear, column shear or flexure, or brace axial as applicable)	Y	Openings at shear walls (concrete or masonry)	N
Load path	Y	Liquefaction	N
Adjacent buildings	Y	Slope failure	N
Weak story	N	Surface fault rupture	N
Soft story	N	Masonry or concrete wall anchorage at flexible diaphragm	N
Geometry (vertical irregularities)	N	URM wall height-to-thickness ratio	N
Torsion	N	URM parapets or cornices	N
Mass – vertical irregularity	N	URM chimney	N
Cripple walls	N	Heavy partitions braced by ceilings	N
Wood sills (bolting)	N	Appendages	N
Diaphragm continuity	N		

Summary of review of non-structural life-safety concerns, including at exit routes.³

No falling hazards observed during the site visit.

No nonstructural life-safety concerns seen in or around the structure.

UCOP non-structural checklist item	Life safety hazard?	UCOP non-structural checklist item	Life safety hazard?
Heavy ceilings, feature or ornamentation above large lecture halls, auditoriums, lobbies or other areas where large numbers of people congregate	N	Unrestrained hazardous materials storage	N
Heavy masonry or stone veneer above exit ways and public access areas	N	Masonry chimneys	N
Unbraced masonry parapets, cornices or other ornamentation above exit ways and public access areas	N	Unrestrained natural gas-fueled equipment such as water heaters, boilers, emergency generators, etc.	N

Discussion of rating

The following noncompliance in the Tier 1 checklist form the basis of rating:

1. The lateral load path of the original structure is not complete. There are insufficient tension only braces to transmit the load to the foundation in the longitudinal direction
2. The original structure and additions are adjacent structures with an unknown sized gap between them. The structures' proximity may result in pounding between an original structure frame and the columns of the southern addition.
3. The moment connection in the portal frames in the original structure are not able to develop the elastic moment of the adjoining members based on an approximate calculation using field measurements. Connection dimensions are unknown for the additions.
4. The tension only bracing in the additions is over stressed based on the quick check.

This building was given a V rating with a priority A due to the serious deficiencies in the lateral load system.

³ For these Tier 1 evaluations, we do not visit all spaces of the building; we rely on campus staff to report to us their understanding of and where non-structural hazards may occur.

Recommendations for further evaluation or retrofit

Removal of finish walls is recommended on the south side of the original structure to document the longitudinal bracing along this wall. Measurement and evaluation of the moment connections in all three structures is also recommended to gain a better understanding of the building's performance.

A full retrofit of the structure's lateral system is necessary. Tension only bracing needs to be added in the longitudinal direction and the frames' moment connections need to be strengthened. Additionally, the additions either need to be tied to the original structure or a larger gap must be created to prevent pounding.

Peer review of rating

This seismic evaluation was discussed in a peer review meeting on 24 June 2019. Reviewers present were Bret Lizundia of R+C and Joe Maffei of Maffei Structural Engineers. Comments from the reviewers have been incorporated into this report. The reviewers agreed with the assigned rating.

Additional building data	Entry	Notes
Latitude	37.000144	
Longitude	-122.061351	
Are there other structures besides this one under the same CAAN#	No	
Number of stories above lowest perimeter grade	1	
Number of stories (basements) below lowest perimeter grade	0	
Building occupiable area (OGSF)	7538 sq ft	
Risk Category per 2016 CBC Table 1604.5	II	
Building structural height, h_n	14 ft., 28 ft	Original structure height, Addition height Structural height defined per ASCE 7-16 Section 11.2
Coefficient for period, C_t	0.02	Estimated using ASCE 41-17 equation 4-4 and 7-18
Coefficient for period, β	0.75	Estimated using ASCE 41-17 equation 4-4 and 7-18
Estimated fundamental period	0.145 sec	Estimated using ASCE 41-17 equation 4-4 and 7-18
Site data		
975 yr hazard parameters S_s, S_1	1.29, 0.49	
Site class	D	
Site class basis	Geotech ⁴	See footnote below
Site parameters F_a, F_v	1.2, 1.819	
Ground motion parameters S_{cs}, S_{c1}	1.548, 0.886	
S_a at building period	1.548	

⁴ Determination of site class and assessment of geotechnical hazards are based on correspondence with Pacific Crest Geotechnical Engineers and Nolan, Zinn, and Associates Geologists. [Revised Geology and Geologic Hazards, Santa Cruz Campus, University of California, Job # 04003-SC 13 May 2005]. Site class is taken as D throughout the main campus of UC Santa Cruz. The following links provide hazard maps for liquefaction, landslide, and fault rupture:

<https://gis.santacruzcounty.us/mapgallery/Emergency%20Management/Hazard%20Mitigation/LiquifactionMap2009.pdf>

<https://gis.santacruzcounty.us/mapgallery/Emergency%20Management/Hazard%20Mitigation/LandslideMap2009.pdf>

<https://gis.santacruzcounty.us/mapgallery/Emergency%20Management/Hazard%20Mitigation/FaultZoneMap2009.pdf>

Site V_{s30}	900 ft/s	
V_{s30} basis	Estimated	Estimated based on site classification of D.
Liquefaction potential	Low	
Liquefaction assessment basis	County Map	See footnote 4
Landslide potential	Low	
Landslide assessment basis	County map	See footnote 4
Active fault-rupture hazard identified at site?	No	
Fault rupture assessment basis	County Map	See footnote 4
Site-specific ground motion study?	No	
Applicable code		
Applicable code or approx. date of original construction	Built: 1966, Addition 1988 Code: 1964 UBC	Inferred based on dated drawings
Applicable code for partial retrofit	None	No partial retrofit
Applicable code for full retrofit	None	No full retrofit
Model building data		
Model building type North-South	Steel,S3 - Metal Building Frames	
Model building type East-West	Steel,S3 - Metal Building Frames	
FEMA P-154 score	No	Not included here because we performed ASCE 41 Tier 1 evaluation.
Previous ratings		
Most recent rating	Unknown	
Date of most recent rating	Unknown	
2 nd most recent rating	-	
Date of 2 nd most recent rating	-	
3 rd most recent rating	-	
Date of 3 rd most recent rating	-	
Appendices		
ASCE 41 Tier 1 checklist included here?	Yes	Refer to attached checklist file in Appendix A.



University of California, Santa Cruz
ASCE 41-17 Tier 1 Seismic Evaluation
7171 - Astronomy Shop A

Appendix A
ASCE 41-17 Checklists

UC Campus:	Santa Cruz		Date:	6/19/2019		
Building CAAN:	7171	Auxiliary CAAN:	By Firm:	Degenkolb Engineers		
Building Name:	Astronomy Shop A		Initials:	JSW	Checked:	
Building Address:	624 Red Hill Road, Santa Cruz, CA 95064		Page:	1	of	3

ASCE 41-17 Collapse Prevention Basic Configuration Checklist

LOW SEISMICITY

BUILDING SYSTEMS - GENERAL

	Description
C NC N/A U <input checked="" type="checkbox"/> <input checked="" type="checkbox"/> <input checked="" type="checkbox"/> <input checked="" type="checkbox"/>	<p>LOAD PATH: The structure contains a complete, well-defined load path, including structural elements and connections, that serves to transfer the inertial forces associated with the mass of all elements of the building to the foundation. (Commentary: Sec. A.2.1.1. Tier 2: Sec. 5.4.1.1)</p> <p>Comments: Lateral bracing observed to be missing in the original structure during site visit. Siding does not appear to be attached well enough to provide lateral restraint.</p>
C NC N/A U <input checked="" type="checkbox"/> <input checked="" type="checkbox"/> <input checked="" type="checkbox"/> <input checked="" type="checkbox"/>	<p>ADJACENT BUILDINGS: The clear distance between the building being evaluated and any adjacent building is greater than 0.25% of the height of the shorter building in low seismicity, 0.5% in moderate seismicity, and 1.5% in high seismicity. (Commentary: Sec. A.2.1.2. Tier 2: Sec. 5.4.1.2)</p> <p>Comments: Eastern addition, southern addition, and existing building have gaps between them. The size of these gaps is unknown.</p>
C NC N/A U <input checked="" type="checkbox"/> <input checked="" type="checkbox"/> <input checked="" type="checkbox"/> <input checked="" type="checkbox"/>	<p>MEZZANINES: Interior mezzanine levels are braced independently from the main structure or are anchored to the seismic-force-resisting elements of the main structure. (Commentary: Sec. A.2.1.3. Tier 2: Sec. 5.4.1.3)</p> <p>Comments:</p>

BUILDING SYSTEMS - BUILDING CONFIGURATION

	Description
C NC N/A U <input checked="" type="checkbox"/> <input checked="" type="checkbox"/> <input checked="" type="checkbox"/> <input checked="" type="checkbox"/>	<p>WEAK STORY: The sum of the shear strengths of the seismic-force-resisting system in any story in each direction is not less than 80% of the strength in the adjacent story above. (Commentary: Sec. A.2.2.2. Tier 2: Sec. 5.4.2.1)</p> <p>Comments:</p>
C NC N/A U <input checked="" type="checkbox"/> <input checked="" type="checkbox"/> <input checked="" type="checkbox"/> <input checked="" type="checkbox"/>	<p>SOFT STORY: The stiffness of the seismic-force-resisting system in any story is not less than 70% of the seismic-force-resisting system stiffness in an adjacent story above or less than 80% of the average seismic-force-resisting system stiffness of the three stories above. (Commentary: Sec. A.2.2.3. Tier 2: Sec. 5.4.2.2)</p> <p>Comments:</p>
C NC N/A U <input checked="" type="checkbox"/> <input checked="" type="checkbox"/> <input checked="" type="checkbox"/> <input checked="" type="checkbox"/>	<p>VERTICAL IRREGULARITIES: All vertical elements in the seismic-force-resisting system are continuous to the foundation. (Commentary: Sec. A.2.2.4. Tier 2: Sec. 5.4.2.3)</p> <p>Comments:</p>

Note: C = Compliant NC = Noncompliant N/A = Not Applicable U = Unknown

UC Campus:	Santa Cruz		Date:	6/19/2019		
Building CAAN:	7171	Auxiliary CAAN:	By Firm:	Degenkolb Engineers		
Building Name:	Astronomy Shop A		Initials:	JSW	Checked:	
Building Address:	624 Red Hill Road, Santa Cruz, CA 95064		Page:	2	of	3

ASCE 41-17 Collapse Prevention Basic Configuration Checklist

C <input checked="" type="checkbox"/> NC <input type="checkbox"/> N/A <input type="checkbox"/> U <input type="checkbox"/>	GEOMETRY: There are no changes in the net horizontal dimension of the seismic-force-resisting system of more than 30% in a story relative to adjacent stories, excluding one-story penthouses and mezzanines. (Commentary: Sec. A.2.2.5. Tier 2: Sec. 5.4.2.4)
	Comments:
C <input checked="" type="checkbox"/> NC <input type="checkbox"/> N/A <input type="checkbox"/> U <input type="checkbox"/>	MASS: There is no change in effective mass of more than 50% from one story to the next. Light roofs, penthouses, and mezzanines need not be considered. (Commentary: Sec. A.2.2.6. Tier 2: Sec. 5.4.2.5)
	Comments:
C <input checked="" type="checkbox"/> NC <input type="checkbox"/> N/A <input type="checkbox"/> U <input type="checkbox"/>	TORSION: The estimated distance between the story center of mass and the story center of rigidity is less than 20% of the building width in either plan dimension. (Commentary: Sec. A.2.2.7. Tier 2: Sec. 5.4.2.6)
	Comments:

MODERATE SEISMICITY (COMPLETE THE FOLLOWING ITEMS IN ADDITION TO THE ITEMS FOR LOW SEISMICITY)

GEOLOGIC SITE HAZARD

	Description
C <input checked="" type="checkbox"/> NC <input type="checkbox"/> N/A <input type="checkbox"/> U <input type="checkbox"/>	LIQUEFACTION: Liquefaction-susceptible, saturated, loose granular soils that could jeopardize the building's seismic performance do not exist in the foundation soils at depths within 50 ft (15.2m) under the building. (Commentary: Sec. A.6.1.1. Tier 2: 5.4.3.1)
	Comments:
C <input checked="" type="checkbox"/> NC <input type="checkbox"/> N/A <input type="checkbox"/> U <input type="checkbox"/>	SLOPE FAILURE: The building site is located away from potential earthquake-induced slope failures or rockfalls so that it is unaffected by such failures or is capable of accommodating any predicted movements without failure. (Commentary: Sec. A.6.1.2. Tier 2: 5.4.3.1)
	Comments:
C <input checked="" type="checkbox"/> NC <input type="checkbox"/> N/A <input type="checkbox"/> U <input type="checkbox"/>	SURFACE FAULT RUPTURE: Surface fault rupture and surface displacement at the building site are not anticipated. (Commentary: Sec. A.6.1.3. Tier 2: 5.4.3.1)
	Comments:

Note: C = Compliant NC = Noncompliant N/A = Not Applicable U = Unknown

UC Campus:	Santa Cruz		Date:	6/19/2019		
Building CAAN:	7171	Auxiliary CAAN:	By Firm:	Degenkolb Engineers		
Building Name:	Astronomy Shop A		Initials:	JSW	Checked:	
Building Address:	624 Red Hill Road, Santa Cruz, CA 95064		Page:	3	of	3

ASCE 41-17 Collapse Prevention Basic Configuration Checklist

HIGH SEISMICITY (COMPLETE THE FOLLOWING ITEMS IN ADDITION TO THE ITEMS FOR MODERATE SEISMICITY)

FOUNDATION CONFIGURATION

	Description
C NC N/A U <input checked="" type="checkbox"/> <input type="checkbox"/> <input type="checkbox"/> <input type="checkbox"/>	<p>OVERTURNING: The ratio of the least horizontal dimension of the seismic-force-resisting system at the foundation level to the building height (base/height) is greater than 0.6S_a. (Commentary: Sec. A.6.2.1. Tier 2: Sec. 5.4.3.3)</p> <p>Comments: 50/14=3.57 0.6*1.548=0.929</p>
C NC N/A U <input checked="" type="checkbox"/> <input type="checkbox"/> <input type="checkbox"/> <input type="checkbox"/>	<p>TIES BETWEEN FOUNDATION ELEMENTS: The foundation has ties adequate to resist seismic forces where footings, piles, and piers are not restrained by beams, slabs, or soils classified as Site Class A, B, or C. (Commentary: Sec. A.6.2.2. Tier 2: Sec. 5.4.3.4)</p> <p>Comments: Grade beams between footings in the addition. Unknown foundations in the existing building</p>

Note: C = Compliant NC = Noncompliant N/A = Not Applicable U = Unknown

UC Campus:	Santa Cruz			Date:	6/19/2019		
Building CAAN:	7171	Auxiliary CAAN:		By Firm:	Degenkolb Engineers		
Building Name:	Astronomy Shop A			Initials:	JSW	Checked:	
Building Address:	624 Red Hill Road, Santa Cruz, CA 95064			Page:	1	of	2

ASCE 41-17 Collapse Prevention Structural Checklist For Building Type S3

LOW AND MODERATE SEISMICITY

SEISMIC-FORCE-RESISTING SYSTEM

	Description
C NC N/A U <input checked="" type="checkbox"/> <input checked="" type="checkbox"/> <input checked="" type="checkbox"/> <input checked="" type="checkbox"/>	BRACE AXIAL STRESS CHECK: The axial stress in the diagonals, calculated using the Quick Check procedure of Section 4.4.3.4, is less than $0.50F_y$. (Commentary: Sec. A.3.3.1.2. Tier 2: Sec. 5.5.4.1) Comments: Brace size unknown. Tension brace missing in original structure. Unable to confirm brace existence on one side of original structure

CONNECTIONS

	Description
C NC N/A U <input checked="" type="checkbox"/> <input checked="" type="checkbox"/> <input checked="" type="checkbox"/> <input checked="" type="checkbox"/>	TRANSFER TO STEEL FRAMES: Diaphragms are connected for transfer of seismic forces to the steel moment frames. (Commentary: Sec. A.5.2.2. Tier 2: Sec. 5.7.2) Comments: Roof diaphragm connected to roof joists that frame into portal frame. Observed on site visit
C NC N/A U <input checked="" type="checkbox"/> <input checked="" type="checkbox"/> <input checked="" type="checkbox"/> <input checked="" type="checkbox"/>	STEEL COLUMNS: The columns in seismic-force-resisting frames are anchored to the building foundation. (Commentary: Sec. A.5.3.1. Tier 2: Sec. 5.7.3.1) Comments:

HIGH SEISMICITY (COMPLETE THE FOLLOWING ITEMS IN ADDITION TO THE ITEMS FOR LOW AND MODERATE SEISMICITY)

SEISMIC-FORCE-RESISTING SYSTEM

	Description
C NC N/A U <input checked="" type="checkbox"/> <input checked="" type="checkbox"/> <input checked="" type="checkbox"/> <input checked="" type="checkbox"/>	MOMENT-RESISTING CONNECTIONS: All moment connections are able to develop the elastic moment ($F_y S$) of the adjoining members. (Commentary: Sec. A.3.1.3.4. Tier 2: Sec. 5.5.2.2.1) Comments: Based on field measurements and approximate calculations the moment connection does not have enough capacity. Connection dimension unknown for additions. Based on estimated stresses from original structure, we extrapolated these frames will have insufficient connection capacity as well.

UC Campus:	Santa Cruz			Date:	6/19/2019		
Building CAAN:	7171	Auxiliary CAAN:		By Firm:	Degenkolb Engineers		
Building Name:	Astronomy Shop A			Initials:	JSW	Checked:	
Building Address:	624 Red Hill Road, Santa Cruz, CA 95064			Page:	2	of	2

ASCE 41-17 Collapse Prevention Structural Checklist For Building Type S3

HIGH SEISMICITY (COMPLETE THE FOLLOWING ITEMS IN ADDITION TO THE ITEMS FOR LOW AND MODERATE SEISMICITY)

SEISMIC-FORCE-RESISTING SYSTEM

C NC N/A U <input checked="" type="checkbox"/> <input type="checkbox"/> <input type="checkbox"/> <input checked="" type="checkbox"/>	COMPACT MEMBERS: All frame elements meet compact section requirements in accordance with AISC 360, Table B4.1. (Commentary: Sec. A.3.1.3.8. Tier 2: Sec. 5.5.2.2.4) Comments: Frame elements for additions could not be checked due to lack of section information
---	--

DIAPHRAGMS

	Description
C NC N/A U <input checked="" type="checkbox"/> <input type="checkbox"/> <input type="checkbox"/> <input type="checkbox"/>	OTHER DIAPHRAGMS: Diaphragms do not consist of a system other than wood, metal deck, concrete, or horizontal bracing. (Commentary: Sec. A.4.7.1. Tier 2: Sec. 5.6.5) Comments:

CONNECTIONS

	Description
C NC N/A U <input checked="" type="checkbox"/> <input type="checkbox"/> <input type="checkbox"/> <input type="checkbox"/>	ROOF PANELS: Where considered as diaphragm elements for lateral resistance, metal, plastic, or cementitious roof panels are positively attached to the roof framing to resist seismic forces. (Commentary: Sec. A.5.5.1. Tier 2: Sec. 5.7.5) Comments: p
C NC N/A U <input type="checkbox"/> <input type="checkbox"/> <input checked="" type="checkbox"/> <input type="checkbox"/>	WALL PANELS: Where considered as shear elements for lateral resistance, metal, fiberglass, or cementitious wall panels are positively attached to the framing and foundation to resist seismic forces. (Commentary: Sec. A.5.5.2. Tier 2: Sec. 5.7.5) Comments:



University of California, Santa Cruz
ASCE 41-17 Tier 1 Seismic Evaluation
7171 - Astronomy Shop A

Appendix B
Quick Check Calculations

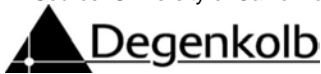

Subject: Global Data	Job Number: B9956006.00	Date: 06/28/19
Job: UCSC Tier 1 Seismic Evaluations - CAAN# 7171 Original	By: JSW	Section:
	Checked By:	Page

GLOBAL DATA

ASCE 41-17 SEISMIC EVALUATION & RETROFIT OF EXISTING BUILDINGS
 CHAPTER 4 - TIER 1 EVALUATION
 LINEAR STATIC PROCEDURE
 COLLAPSE PREVENTION
 BSE-2E HAZARD LEVEL

SITE DATA:

Latitude:	37.001 °N	103 McAllister Way	USGS Seismic Design Map Application:
Longitude:	-122.061339 °W	Santa Cruz CA 95060	http://geohazards.usgs.gov/hazardtool/application.php
Site Class:	D (default)	(Stiff Soil)	Site Class [ASCE 41-17, §2.4.1.6]
S _s =	1.290 g	(USGS) (5% / 50 years)	USGS Mapped (T = 0.2 sec) [ASCE 41-17, §2.4.1.3]
S ₁ =	0.490 g	(USGS) (5% / 50 years)	USGS Mapped (T = 1.0 sec) [ASCE 41-17, §2.4.1.3]
F _a =	1.200	(Site Class D)	Site Coefficient (T = 0.2 sec) [ASCE 7-16, Table 11.4-1]
F _v =	1.810	(Site Class D)	Site Coefficient (T = 1.0 sec) [ASCE 7-16, Table 11.4-2]
S _{Xs} =	1.548 g	= F _a S _s	Site-Adjusted Design (T = 0.2 sec) [ASCE 41-17, Eq. 2-1]
S _{X1} =	0.887 g	= F _v S ₁	Site-Adjusted Design (T = 1.0 sec) [ASCE 41-17, Eq. 2-2]

BUILDING DATA:

Building Type:	S3	(Metal Building Frames)	[ASCE 41-17, Table 3-1]
Year Built:	1966		
Number of Stories:	1 story		
Parapet Height:	0.00 ft		
Roof Height:	14.00 ft		
Total Area:	6,000 sf		

Level	Height [ft]	Elevation [ft]	Length _{N-S} [ft]	Length _{E-W} [ft]	Area [sf]	Diaphragm Stiffness	Diaphragm Description
Roof	14.0	14.0	50	120	6,000	Flexible	Lightweight metal deck
1st	0.0	0.0	50	120	6,000	-	-

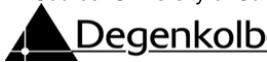

Subject: Weight Take Off	Job Number: B9956006.00	Date: 06/28/19
Job: UCSC Tier 1 Seismic Evaluations - CAAN# 7171 Original	By: JSW	Section:
Checked By:		Page

WEIGHT TAKEOFF

ASCE 41-17 SEISMIC EVALUATION & RETROFIT OF EXISTING BUILDINGS
 CHAPTER 4 - TIER 1 EVALUATION
 LINEAR STATIC PROCEDURE
 COLLAPSE PREVENTION
 BSE-2E HAZARD LEVEL

ROOF TYPE: ROOF

	Roofing / Re-roofing	@	5.0 psf	5.0 psf	y
0.5 in	Rock Ballast (Gravel)	@	8.0 psf per inch	0.0 psf	n
3 ply	Ready Roofing	@	0.3 psf per ply	0.0 psf	n
5 ply	Felt Roofing	@	0.5 psf per ply	0.0 psf	n
0.25 in	Slate	@	40.0 psf per inch	0.0 psf	n
	Shingles (Asphalt)	@	2.0 psf	0.0 psf	n
	Copper or Tin	@	1.0 psf	0.0 psf	n
	Corrugated Asbestos-Cement	@	4.0 psf	0.0 psf	n
	Waterproofing Membranes (Smooth Bituminous)	@	1.5 psf	0.0 psf	n
	Cement Tiles	@	16.0 psf	0.0 psf	n
	Clay Tiles (Spanish)	@	19.0 psf	0.0 psf	n
	Mortar Bed for Clay Tiles	@	10.0 psf	0.0 psf	n
	Roof Insulation	@	1.0 psf	1.0 psf	y
1 in	Insulation (Rigid)	@	1.5 psf per inch	0.0 psf	n
1 in	Insulation Boards (Fibrous Glass)	@	1.1 psf per inch	0.0 psf	n
3 in	Vermiculite Concrete	@	2.5 psf per inch	0.0 psf	n
0.5 in	Fire Proofing	@	2.0 psf per inch	0.0 psf	n
	Diaphragm - core planks	@	35.0 psf	0.0 psf	n
2.5 in	Concrete Slab (Normal Weight)	@	12.5 psf per inch	0.0 psf	n
4.75 in	Concrete Fill (Light Weight)	@	9.2 psf per inch	0.0 psf	n
0.5 in	Concrete Overpour (Light Weight)	@	9.2 psf per inch	0.0 psf	n
18 ga	Bare Metal Deck	@	3.0 psf	3.0 psf	y
2 in	Wood Decking	@	2.5 psf per inch	0.0 psf	n
2 in	Wood Sheathing	@	3.0 psf per inch	0.0 psf	n
0.5 in	Plywood	@	3.2 psf per inch	0.0 psf	n
	Framing	@	20.0 psf	0.0 psf	n
6 ft O.C.	Steel Beams	@	22.0 plf	0.0 psf	n
36 ft O.C.	Steel Girders	@	76.0 plf	0.0 psf	n
2 ft O.C.	Wood Sub-Purlins	@	1.8 plf	0.0 psf	n
8 ft O.C.	Wood Purlins	@	3.0 plf	0.0 psf	n
20 ft O.C.	Wood Girders	@	5.0 plf	0.0 psf	n
12.75 ft O.C.	Concrete Beams	@	800.0 plf	0.0 psf	n
20 ft O.C.	Concrete Girders	@	300.0 plf	0.0 psf	n
7.00 ft trib. ht.	Typical Columns (A _{trib} = 500 sf)	@	38.0 plf	0.5 psf	y
	Ceiling	@	5.0 psf	5.0 psf	y
0.5 in	Gypsum Board Ceiling	@	4.4 psf per inch	0.0 psf	n
	Acoustical Fiber Board	@	1.0 psf	0.0 psf	n
	Plaster Ceiling (On Tile)	@	5.0 psf	0.0 psf	n
	Suspended Metal Lath & Plaster (Gypsum Plaster)	@	10.0 psf	0.0 psf	n
	Suspended Steel Channel System	@	2.0 psf	0.0 psf	n
	Suspended Wood Furring System	@	2.5 psf	0.0 psf	n
	T-bar Ceiling System	@	3.0 psf	0.0 psf	n
100% floor area	Interior Partitions (Below)	@	5.0 psf	5.0 psf	y
	M.E.P.	@	5.0 psf	5.0 psf	y
	Miscellaneous	@	1.5 psf	1.5 psf	y
	Other	@	0.0 psf	0.0 psf	n
	Other	@	1.0 psf	0.0 psf	n
	Other	@	1.0 psf	0.0 psf	n
	Other	@	1.0 psf	0.0 psf	n
	Other	@	1.0 psf	0.0 psf	n
	Other	@	1.0 psf	0.0 psf	n

ROOF WEIGHT = 26.0 psf

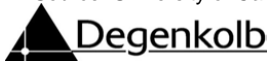

Subject: Weight Take Off	Job Number: B9956006.00	Date: 06/28/19
Job: UCSC Tier 1 Seismic Evaluations - CAAN# 7171 Original	By: JSW	Section:
Checked By:		Page

WEIGHT TAKEOFF

ASCE 41-17 SEISMIC EVALUATION & RETROFIT OF EXISTING BUILDINGS
 CHAPTER 4 - TIER 1 EVALUATION
 LINEAR STATIC PROCEDURE
 COLLAPSE PREVENTION
 BSE-2E HAZARD LEVEL

WALL TYPE: **WALL-R**

	Wall Covering	@	4.0 psf	4.0 psf	y
1 in	Exterior Stucco	@	11.4 psf per inch.	0.0 psf	n
1 in	Wood Sheathing	@	3.0 psf per inch	0.0 psf	n
0.5 in	Gypsum Sheathing	@	4.0 psf per inch	0.0 psf	n
0.5 in	Gypsum Wallboard	@	4.4 psf per inch	0.0 psf	n
	Porcelain Enamel Panels	@	5.0 psf	0.0 psf	n
	Metal Lath & Plaster (Gypsum Plaster)	@	10.0 psf	0.0 psf	n
	Wall Insulation	@	1.0 psf	1.0 psf	y
1 in	Insulation (Rigid)	@	1.5 psf per inch	0.0 psf	n
1 in	Insulation Boards (Fiber Board)	@	1.5 psf per inch	0.0 psf	n
0.5 in	Fire Proofing	@	2 psf per inch	0.0 psf	n
	Wall Framing	@	10.0 psf	10.0 psf	y
8 in	Concrete Wall (Normal Weight)	@	12.5 psf per inch	0.0 psf	n
8 in	CMU Wall w/ Full Grouting (Normal Weight)	@	83.0 psf	0.0 psf	n
8 in	Solid CMU Wall (Normal Weight)	@	87.0 psf	0.0 psf	n
4 in	HCB Wall w/ Full Grouting	@	38.0 psf	0.0 psf	n
3.5 in	Solid Clay Brick Wall	@	11.1 psf per inch	0.0 psf	n
0.5 in	Plywood	@	3.2 psf per inch	0.0 psf	n
16 in O.C.	Wood Studs (2 x 4)	@	1.1 plf	0.0 psf	n
16 in O.C.	Metal Channel Studs	@	2.0 plf	0.0 psf	n
8 ft O.C.	Steel Girts	@	6.0 plf	0.0 psf	n
	Miscellaneous	@	1.0 psf	1.0 psf	y
	Other	@	1.0 psf	0.0 psf	n
	Other	@	1.0 psf	0.0 psf	n
	Other	@	1.0 psf	0.0 psf	n
	Other	@	1.0 psf	0.0 psf	n
	Other	@	1.0 psf	0.0 psf	n

Solid Wall Weight = 16.0 psf
 Window & Door Weight = 8.0 psf
 % Solid Wall = 80%
WALL-R WEIGHT = 14.4 psf

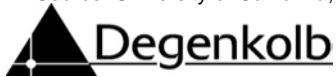

Subject: Seismic Mass	Job Number: B9956006.00	Date: 06/28/19
Job: UCSC Tier 1 Seismic Evaluations - CAAN# 7171 Original	By: JSW	Section:
	Checked By:	Page

SEISMIC MASS

ASCE 41-17 SEISMIC EVALUATION & RETROFIT OF EXISTING BUILDINGS
 CHAPTER 4 - TIER 1 EVALUATION
 LINEAR STATIC PROCEDURE
 COLLAPSE PREVENTION
 BSE-2E HAZARD LEVEL

ROOF/FLOOR WEIGHT SUMMARY:

Level Type	Weight [psf]
ROOF	26

WALL WEIGHT SUMMARY:

Wall Type	Weight [psf]		
	Net	Solid	Openings
WALL-P	26.0	26	8
WALL-R	14.4	16	8

SEISMIC MASS SUMMARY:

Level	FLOOR			WALL ABOVE				WALL BELOW				TOTAL WEIGHT [kips]
	Level Type	Weight [psf]	Area [sf]	Wall Type	Weight [psf]	Length [ft]	Height [ft]	Wall Type	Weight [psf]	Length [ft]	Height [ft]	
Roof	ROOF	26	6,000	WALL-P	26.0	0	0.00	WALL-R	14.4	0	7.00	156
											TOTAL	156

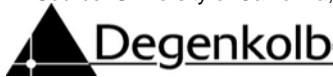

Subject: Seismic Forces	Job Number: B9956006.00	Date: 06/28/19
Job: UCSC Tier 1 Seismic Evaluations - CAAN# 7171 Original	By: JSW	Section:
	Checked By:	Page:

SEISMIC FORCES

ASCE 41-17 SEISMIC EVALUATION & RETROFIT OF EXISTING BUILDINGS
 CHAPTER 4 - TIER 1 EVALUATION
 LINEAR STATIC PROCEDURE
 COLLAPSE PREVENTION
 BSE-2E HAZARD LEVEL

BUILDING TYPE: S3 (Metal Building Frames) [ASCE 41-17, Table 3-1]
SITE CLASS: D (default) #N/A [ASCE 41-17, §2.4.1.6]

DESIGN SPECTRAL ACCELERATIONS:

S_{XS} = 1.548 g (BSE-2E) Site-Adjusted Design (T = 0.2 sec) [ASCE 41-17, Eq. 2-1]
 S_{X1} = 0.887 g (BSE-2E) Site-Adjusted Design (T = 1.0 sec) [ASCE 41-17, Eq. 2-2]

BUILDING PERIOD:

h_n = 14.0 ft (Base to Roof) Building Height [ASCE 41-17, §4.4.2.4]
 C_t = 0.020 (Building Type S3) Period Coefficient [ASCE 41-17, §4.4.2.4]
 β = 0.750 (Building Type S3) Period Exponent [ASCE 41-17, §4.4.2.4]
 T = 0.145 sec = $C_t h_n^\beta$ Fundamental Period [ASCE 41-17, Eq. 4-4]

RESPONSE SPECTRUM:

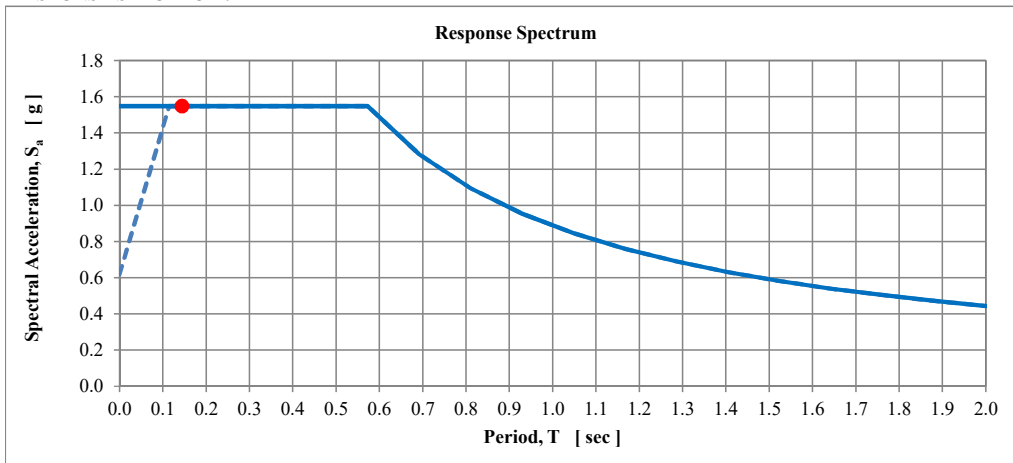

PSEUDO LATERAL FORCE:

n = 1 (n = 1) Total Number of Stories
 C = 1.3 (Building Type S3) Modification Factor [ASCE 41-17, Table 4-7]
 S_a = 1.548 g = MIN { S_{X1} / T , S_{XS} } Spectral Acceleration [ASCE 41-17, Eq. 4-3]
 V = 2.012 W = $C S_a W$ Pseudo Lateral Force [ASCE 41-17, Eq. 4-1]

VERTICAL DISTRIBUTION OF SEISMIC FORCES:

k = 1.00 ($T \leq 0.5$ sec) Seismic Distribution Exponent [ASCE 41-17, §4.4.2.2]

Level	h_x [ft]	w_x [kips]	$w_x h_x^k$	C_{vx}	F_x [kips]	V_j [kips]
Roof	14.0	156	2,184	1.00	314	314
TOTAL	-	156	2,184	1.00	314	-

$F_x = C_{vx} V = [w_x h_x^k / \Sigma (w_x h_x^k)] V$ [ASCE 41-17, Eq. 4-2a]
 $V_j = \Sigma F_x$ [ASCE 41-17, Eq. 4-2b]

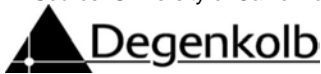

Subject: Global Data	Job Number: B9956006.00	Date: 06/28/19
Job: UCSC Tier 1 Seismic Evaluations - CAAN# 7171	By: JSW	Section:
	Checked By:	Page

GLOBAL DATA

ASCE 41-17 SEISMIC EVALUATION & RETROFIT OF EXISTING BUILDINGS
 CHAPTER 4 - TIER 1 EVALUATION
 LINEAR STATIC PROCEDURE
 COLLAPSE PREVENTION
 BSE-2E HAZARD LEVEL

SITE DATA:

Latitude:	37.001 °N	103 McAllister Way	USGS Seismic Design Map Application:
Longitude:	-122.061339 °W	Santa Cruz CA 95060	http://geohazards.usgs.gov/hazardtool/application.php
Site Class:	D (default)	(Stiff Soil)	Site Class [ASCE 41-17, §2.4.1.6]
S _s =	1.290 g	(USGS) (5% / 50 years)	USGS Mapped (T = 0.2 sec) [ASCE 41-17, §2.4.1.3]
S ₁ =	0.490 g	(USGS) (5% / 50 years)	USGS Mapped (T = 1.0 sec) [ASCE 41-17, §2.4.1.3]
F _a =	1.200	(Site Class D)	Site Coefficient (T = 0.2 sec) [ASCE 7-16, Table 11.4-1]
F _v =	1.810	(Site Class D)	Site Coefficient (T = 1.0 sec) [ASCE 7-16, Table 11.4-2]
S _{XS} =	1.548 g	= F _a S _s	Site-Adjusted Design (T = 0.2 sec) [ASCE 41-17, Eq. 2-1]
S _{X1} =	0.887 g	= F _v S ₁	Site-Adjusted Design (T = 1.0 sec) [ASCE 41-17, Eq. 2-2]

BUILDING DATA:

Building Type:	S3	(Metal Building Frames)	[ASCE 41-17, Table 3-1]
Year Built:	1966		
Number of Stories:	1 story		
Parapet Height:	0.00 ft		
Roof Height:	14.00 ft		
Total Area:	360 sf		

Level	Height [ft]	Elevation [ft]	Length _{N-S} [ft]	Length _{E-W} [ft]	Area [sf]	Diaphragm Stiffness	Diaphragm Description
Roof	14.0	14.0	12	30	360	Flexible	Lightweight metal deck
1st	0.0	0.0	12	30	360	-	-

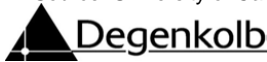

Subject: Weight Take Off	Job Number: B9956006.00	Date: 06/28/19
Job: UCSC Tier 1 Seismic Evaluations - CAAN# 7171	By: JSW	Section:
Checked By:		Page

WEIGHT TAKEOFF

ASCE 41-17 SEISMIC EVALUATION & RETROFIT OF EXISTING BUILDINGS
 CHAPTER 4 - TIER 1 EVALUATION
 LINEAR STATIC PROCEDURE
 COLLAPSE PREVENTION
 BSE-2E HAZARD LEVEL

ROOF TYPE:		ROOF				
		Roofing / Re-roofing	@	5.0 psf	5.0 psf	y
0.5 in		Rock Ballast (Gravel)	@	8.0 psf per inch	0.0 psf	n
3 ply		Ready Roofing	@	0.3 psf per ply	0.0 psf	n
5 ply		Felt Roofing	@	0.5 psf per ply	0.0 psf	n
0.25 in		Slate	@	40.0 psf per inch	0.0 psf	n
		Shingles (Asphalt)	@	2.0 psf	0.0 psf	n
		Copper or Tin	@	1.0 psf	0.0 psf	n
		Corrugated Asbestos-Cement	@	4.0 psf	0.0 psf	n
		Waterproofing Membranes (Smooth Bituminous)	@	1.5 psf	0.0 psf	n
		Cement Tiles	@	16.0 psf	0.0 psf	n
		Clay Tiles (Spanish)	@	19.0 psf	0.0 psf	n
		Mortar Bed for Clay Tiles	@	10.0 psf	0.0 psf	n
		Roof Insulation	@	1.0 psf	1.0 psf	y
1 in		Insulation (Rigid)	@	1.5 psf per inch	0.0 psf	n
1 in		Insulation Boards (Fibrous Glass)	@	1.1 psf per inch	0.0 psf	n
3 in		Vermiculite Concrete	@	2.5 psf per inch	0.0 psf	n
0.5 in		Fire Proofing	@	2.0 psf per inch	0.0 psf	n
		Diaphragm - core planks	@	35.0 psf	0.0 psf	n
2.5 in		Concrete Slab (Normal Weight)	@	12.5 psf per inch	0.0 psf	n
4.75 in		Concrete Fill (Light Weight)	@	9.2 psf per inch	0.0 psf	n
0.5 in		Concrete Overpour (Light Weight)	@	9.2 psf per inch	0.0 psf	n
18 ga		Bare Metal Deck	@	3.0 psf	3.0 psf	y
2 in		Wood Decking	@	2.5 psf per inch	0.0 psf	n
2 in		Wood Sheathing	@	3.0 psf per inch	0.0 psf	n
0.5 in		Plywood	@	3.2 psf per inch	0.0 psf	n
		Framing	@	20.0 psf	0.0 psf	n
6 ft O.C.		Steel Beams	@	22.0 plf	0.0 psf	n
36 ft O.C.		Steel Girders	@	76.0 plf	0.0 psf	n
2 ft O.C.		Wood Sub-Purlins	@	1.8 plf	0.0 psf	n
8 ft O.C.		Wood Purlins	@	3.0 plf	0.0 psf	n
20 ft O.C.		Wood Girders	@	5.0 plf	0.0 psf	n
12.75 ft O.C.		Concrete Beams	@	800.0 plf	0.0 psf	n
20 ft O.C.		Concrete Girders	@	300.0 plf	0.0 psf	n
7.00 ft trib. ht.		Typical Columns (A _{trib} = 500 sf)	@	38.0 plf	0.5 psf	y
		Ceiling	@	5.0 psf	5.0 psf	y
0.5 in		Gypsum Board Ceiling	@	4.4 psf per inch	0.0 psf	n
		Acoustical Fiber Board	@	1.0 psf	0.0 psf	n
		Plaster Ceiling (On Tile)	@	5.0 psf	0.0 psf	n
		Suspended Metal Lath & Plaster (Gypsum Plaster)	@	10.0 psf	0.0 psf	n
		Suspended Steel Channel System	@	2.0 psf	0.0 psf	n
		Suspended Wood Furring System	@	2.5 psf	0.0 psf	n
		T-bar Ceiling System	@	3.0 psf	0.0 psf	n
100% floor area		Interior Partitions (Below)	@	5.0 psf	5.0 psf	y
		M.E.P.	@	5.0 psf	5.0 psf	y
		Miscellaneous	@	1.5 psf	1.5 psf	y
		Other	@	0.0 psf	0.0 psf	n
		Other	@	1.0 psf	0.0 psf	n
		Other	@	1.0 psf	0.0 psf	n
		Other	@	1.0 psf	0.0 psf	n
		Other	@	1.0 psf	0.0 psf	n
		Other	@	1.0 psf	0.0 psf	n

ROOF WEIGHT = 26.0 psf

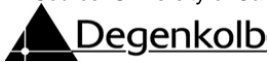

Subject: Weight Take Off	Job Number: B9956006.00	Date: 06/28/19
Job: UCSC Tier 1 Seismic Evaluations - CAAN# 7171	By: JSW	Section:
	Checked By:	Page

WEIGHT TAKEOFF

ASCE 41-17 SEISMIC EVALUATION & RETROFIT OF EXISTING BUILDINGS
 CHAPTER 4 - TIER 1 EVALUATION
 LINEAR STATIC PROCEDURE
 COLLAPSE PREVENTION
 BSE-2E HAZARD LEVEL

WALL TYPE: **WALL-R**

	Wall Covering	@	4.0 psf	4.0 psf	y
1 in	Exterior Stucco	@	11.4 psf per inch.	0.0 psf	n
1 in	Wood Sheathing	@	3.0 psf per inch	0.0 psf	n
0.5 in	Gypsum Sheathing	@	4.0 psf per inch	0.0 psf	n
0.5 in	Gypsum Wallboard	@	4.4 psf per inch	0.0 psf	n
	Porcelain Enamel Panels	@	5.0 psf	0.0 psf	n
	Metal Lath & Plaster (Gypsum Plaster)	@	10.0 psf	0.0 psf	n
	Wall Insulation	@	1.0 psf	1.0 psf	y
1 in	Insulation (Rigid)	@	1.5 psf per inch	0.0 psf	n
1 in	Insulation Boards (Fiber Board)	@	1.5 psf per inch	0.0 psf	n
0.5 in	Fire Proofing	@	2 psf per inch	0.0 psf	n
	Wall Framing	@	20.0 psf	20.0 psf	y
8 in	Concrete Wall (Normal Weight)	@	12.5 psf per inch	0.0 psf	n
8 in	CMU Wall w/ Full Grouting (Normal Weight)	@	83.0 psf	0.0 psf	n
8 in	Solid CMU Wall (Normal Weight)	@	87.0 psf	0.0 psf	n
4 in	HCB Wall w/ Full Grouting	@	38.0 psf	0.0 psf	n
3.5 in	Solid Clay Brick Wall	@	11.1 psf per inch	0.0 psf	n
0.5 in	Plywood	@	3.2 psf per inch	0.0 psf	n
16 in O.C.	Wood Studs (2 x 4)	@	1.1 plf	0.0 psf	n
16 in O.C.	Metal Channel Studs	@	2.0 plf	0.0 psf	n
8 ft O.C.	Steel Girts	@	6.0 plf	0.0 psf	n
	Miscellaneous	@	1.0 psf	1.0 psf	y
	Other	@	1.0 psf	0.0 psf	n
	Other	@	1.0 psf	0.0 psf	n
	Other	@	1.0 psf	0.0 psf	n
	Other	@	1.0 psf	0.0 psf	n
	Other	@	1.0 psf	0.0 psf	n

Solid Wall Weight = 26.0 psf
 Window & Door Weight = 8.0 psf
 % Solid Wall = 80%
WALL-R WEIGHT = 22.4 psf

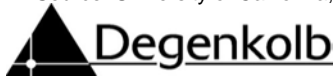

Subject: Seismic Mass	Job Number: B9956006.00	Date: 06/28/19
Job: UCSC Tier 1 Seismic Evaluations - CAAN# 7171	By: JSW	Section:
	Checked By:	Page

SEISMIC MASS

ASCE 41-17 SEISMIC EVALUATION & RETROFIT OF EXISTING BUILDINGS
 CHAPTER 4 - TIER 1 EVALUATION
 LINEAR STATIC PROCEDURE
 COLLAPSE PREVENTION
 BSE-2E HAZARD LEVEL

ROOF/FLOOR WEIGHT SUMMARY:

Level Type	Weight [psf]
ROOF	26

WALL WEIGHT SUMMARY:

Wall Type	Weight [psf]		
	Net	Solid	Openings
WALL-P	26.0	26	8
WALL-R	22.4	26	8

SEISMIC MASS SUMMARY:

Level	FLOOR			WALL ABOVE				WALL BELOW				TOTAL WEIGHT [kips]
	Level Type	Weight [psf]	Area [sf]	Wall Type	Weight [psf]	Length [ft]	Height [ft]	Wall Type	Weight [psf]	Length [ft]	Height [ft]	
Roof	ROOF	26	360	WALL-P	26.0	0	0.00	WALL-R	22.4	0	7.00	9
											TOTAL	9

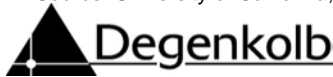

Subject: Seismic Forces	Job Number: B9956006.00	Date: 06/28/19
Job: UCSC Tier 1 Seismic Evaluations - CAAN# 7171	By: JSW	Section:
	Checked By:	Page:

SEISMIC FORCES

ASCE 41-17 SEISMIC EVALUATION & RETROFIT OF EXISTING BUILDINGS
 CHAPTER 4 - TIER 1 EVALUATION
 LINEAR STATIC PROCEDURE
 COLLAPSE PREVENTION
 BSE-2E HAZARD LEVEL

BUILDING TYPE: S3 (Metal Building Frames) [ASCE 41-17, Table 3-1]
SITE CLASS: D (default) #N/A [ASCE 41-17, §2.4.1.6]

DESIGN SPECTRAL ACCELERATIONS:

S_{XS} = 1.548 g (BSE-2E) Site-Adjusted Design (T = 0.2 sec) [ASCE 41-17, Eq. 2-1]
 S_{X1} = 0.887 g (BSE-2E) Site-Adjusted Design (T = 1.0 sec) [ASCE 41-17, Eq. 2-2]

BUILDING PERIOD:

h_n = 14.0 ft (Base to Roof) Building Height [ASCE 41-17, §4.4.2.4]
 C_t = 0.020 (Building Type S3) Period Coefficient [ASCE 41-17, §4.4.2.4]
 β = 0.750 (Building Type S3) Period Exponent [ASCE 41-17, §4.4.2.4]
 T = 0.145 sec = $C_t h_n^\beta$ Fundamental Period [ASCE 41-17, Eq. 4-4]

RESPONSE SPECTRUM:

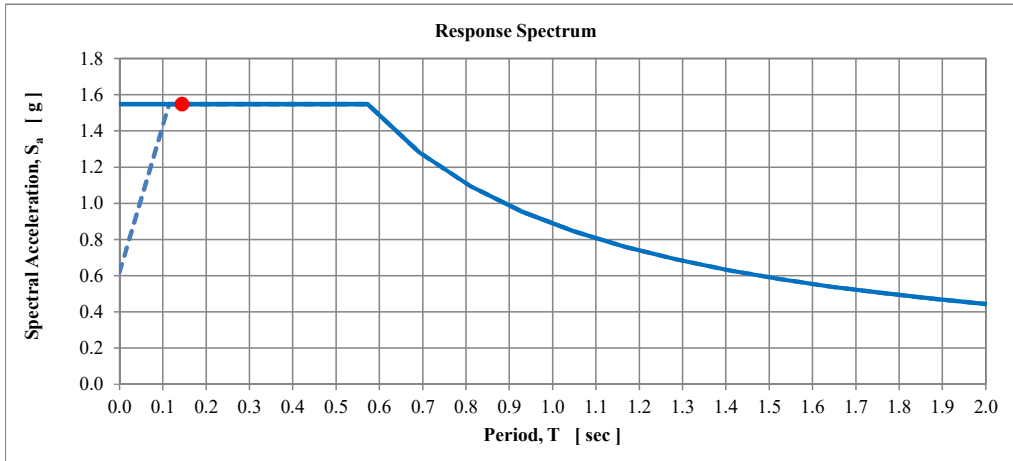

PSEUDO LATERAL FORCE:

n = 1 (n = 1) Total Number of Stories
 C = 1.3 (Building Type S3) Modification Factor [ASCE 41-17, Table 4-7]
 S_a = 1.548 g = MIN { S_{X1} / T , S_{XS} } Spectral Acceleration [ASCE 41-17, Eq. 4-3]
 V = 2.012 W = $C S_a W$ Pseudo Lateral Force [ASCE 41-17, Eq. 4-1]

VERTICAL DISTRIBUTION OF SEISMIC FORCES:

k = 1.00 ($T \leq 0.5$ sec) Seismic Distribution Exponent [ASCE 41-17, §4.4.2.2]

Level	h_x [ft]	w_x [kips]	$w_x h_x^k$	C_{vx}	F_x [kips]	V_j [kips]
Roof	14.0	9	131	1.00	19	19
TOTAL	-	9	131	1.00	19	-

$F_x = C_{vx} V = [w_x h_x^k / \sum (w_x h_x^k)] V$ [ASCE 41-17, Eq. 4-2a]
 $V_j = \sum F_x$ [ASCE 41-17, Eq. 4-2b]



Subject: Global Data	Job Number: B9956006.00	Date: 06/28/19
Job: UCSC Tier 1 Seismic Evaluations - CAAN# 7171 Eastern Addition	By: JSW	Section:
	Checked By:	Page

GLOBAL DATA

ASCE 41-17 SEISMIC EVALUATION & RETROFIT OF EXISTING BUILDINGS
 CHAPTER 4 - TIER 1 EVALUATION
 LINEAR STATIC PROCEDURE
 COLLAPSE PREVENTION
 BSE-2E HAZARD LEVEL

SITE DATA:

Latitude:	37.001 °N	103 McAllister Way	USGS Seismic Design Map Application:
Longitude:	-122.061339 °W	Santa Cruz CA 95060	http://geohazards.usgs.gov/hazardtool/application.php
Site Class:	D (default)	(Stiff Soil)	Site Class [ASCE 41-17, §2.4.1.6]
S _s =	1.290 g	(USGS) (5% / 50 years)	USGS Mapped (T = 0.2 sec) [ASCE 41-17, §2.4.1.3]
S ₁ =	0.490 g	(USGS) (5% / 50 years)	USGS Mapped (T = 1.0 sec) [ASCE 41-17, §2.4.1.3]
F _a =	1.200	(Site Class D)	Site Coefficient (T = 0.2 sec) [ASCE 7-16, Table 11.4-1]
F _v =	1.810	(Site Class D)	Site Coefficient (T = 1.0 sec) [ASCE 7-16, Table 11.4-2]
S _{XS} =	1.548 g	= F _a S _s	Site-Adjusted Design (T = 0.2 sec) [ASCE 41-17, Eq. 2-1]
S _{X1} =	0.887 g	= F _v S ₁	Site-Adjusted Design (T = 1.0 sec) [ASCE 41-17, Eq. 2-2]

BUILDING DATA:

Building Type:	S3	(Metal Building Frames)	[ASCE 41-17, Table 3-1]
Year Built:	1966		
Number of Stories:	1 story		
Parapet Height:	0.00 ft		
Roof Height:	28.00 ft		
Total Area:	1,701 sf		

Level	Height [ft]	Elevation [ft]	Length _{N-S} [ft]	Length _{E-W} [ft]	Area [sf]	Diaphragm Stiffness	Diaphragm Description
Roof	14.0	28.0	63	27	1,688	Flexible	Lightweight metal deck
1st	0.0	0.0	63	27	1,701	-	-

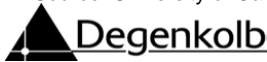

Subject: Weight Take Off	Job Number: B9956006.00	Date: 06/28/19
Job: UCSC Tier 1 Seismic Evaluations - CAAN# 7171 Eastern Addition	By: JSW	Section:
Checked By:		Page

WEIGHT TAKEOFF

ASCE 41-17 SEISMIC EVALUATION & RETROFIT OF EXISTING BUILDINGS
 CHAPTER 4 - TIER 1 EVALUATION
 LINEAR STATIC PROCEDURE
 COLLAPSE PREVENTION
 BSE-2E HAZARD LEVEL

ROOF TYPE: ROOF

	Roofing / Re-roofing	@	5.0 psf	5.0 psf	y
0.5 in	Rock Ballast (Gravel)	@	8.0 psf per inch	0.0 psf	n
3 ply	Ready Roofing	@	0.3 psf per ply	0.0 psf	n
5 ply	Felt Roofing	@	0.5 psf per ply	0.0 psf	n
0.25 in	Slate	@	40.0 psf per inch	0.0 psf	n
	Shingles (Asphalt)	@	2.0 psf	0.0 psf	n
	Copper or Tin	@	1.0 psf	0.0 psf	n
	Corrugated Asbestos-Cement	@	4.0 psf	0.0 psf	n
	Waterproofing Membranes (Smooth Bituminous)	@	1.5 psf	0.0 psf	n
	Cement Tiles	@	16.0 psf	0.0 psf	n
	Clay Tiles (Spanish)	@	19.0 psf	0.0 psf	n
	Mortar Bed for Clay Tiles	@	10.0 psf	0.0 psf	n
	Roof Insulation	@	1.0 psf	1.0 psf	y
1 in	Insulation (Rigid)	@	1.5 psf per inch	0.0 psf	n
1 in	Insulation Boards (Fibrous Glass)	@	1.1 psf per inch	0.0 psf	n
3 in	Vermiculite Concrete	@	2.5 psf per inch	0.0 psf	n
0.5 in	Fire Proofing	@	2.0 psf per inch	0.0 psf	n
	Diaphragm - core planks	@	35.0 psf	0.0 psf	n
2.5 in	Concrete Slab (Normal Weight)	@	12.5 psf per inch	0.0 psf	n
4.75 in	Concrete Fill (Light Weight)	@	9.2 psf per inch	0.0 psf	n
0.5 in	Concrete Overpour (Light Weight)	@	9.2 psf per inch	0.0 psf	n
18 ga	Bare Metal Deck	@	3.0 psf	3.0 psf	y
2 in	Wood Decking	@	2.5 psf per inch	0.0 psf	n
2 in	Wood Sheathing	@	3.0 psf per inch	0.0 psf	n
0.5 in	Plywood	@	3.2 psf per inch	0.0 psf	n
	Framing	@	20.0 psf	0.0 psf	n
6 ft O.C.	Steel Beams	@	22.0 plf	0.0 psf	n
36 ft O.C.	Steel Girders	@	76.0 plf	0.0 psf	n
2 ft O.C.	Wood Sub-Purlins	@	1.8 plf	0.0 psf	n
8 ft O.C.	Wood Purlins	@	3.0 plf	0.0 psf	n
20 ft O.C.	Wood Girders	@	5.0 plf	0.0 psf	n
12.75 ft O.C.	Concrete Beams	@	800.0 plf	0.0 psf	n
20 ft O.C.	Concrete Girders	@	300.0 plf	0.0 psf	n
7.00 ft trib. ht.	Typical Columns (A _{trib} = 500 sf)	@	38.0 plf	0.5 psf	y
	Ceiling	@	5.0 psf	5.0 psf	y
0.5 in	Gypsum Board Ceiling	@	4.4 psf per inch	0.0 psf	n
	Acoustical Fiber Board	@	1.0 psf	0.0 psf	n
	Plaster Ceiling (On Tile)	@	5.0 psf	0.0 psf	n
	Suspended Metal Lath & Plaster (Gypsum Plaster)	@	10.0 psf	0.0 psf	n
	Suspended Steel Channel System	@	2.0 psf	0.0 psf	n
	Suspended Wood Furring System	@	2.5 psf	0.0 psf	n
	T-bar Ceiling System	@	3.0 psf	0.0 psf	n
100% floor area	Interior Partitions (Below)	@	5.0 psf	5.0 psf	y
	M.E.P.	@	5.0 psf	5.0 psf	y
	Miscellaneous	@	1.5 psf	1.5 psf	y
	Other	@	0.0 psf	0.0 psf	n
	Other	@	1.0 psf	0.0 psf	n
	Other	@	1.0 psf	0.0 psf	n
	Other	@	1.0 psf	0.0 psf	n
	Other	@	1.0 psf	0.0 psf	n
	Other	@	1.0 psf	0.0 psf	n

ROOF WEIGHT = 26.0 psf

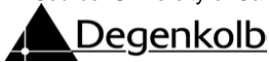

Subject: Weight Take Off	Job Number: B9956006.00	Date: 06/28/19
Job: UCSC Tier 1 Seismic Evaluations - CAAN# 7171 Eastern Addition	By: JSW	Section:
Checked By:		Page

WEIGHT TAKEOFF

ASCE 41-17 SEISMIC EVALUATION & RETROFIT OF EXISTING BUILDINGS
 CHAPTER 4 - TIER 1 EVALUATION
 LINEAR STATIC PROCEDURE
 COLLAPSE PREVENTION
 BSE-2E HAZARD LEVEL

WALL TYPE: **WALL-R**

	Wall Covering	@	4.0 psf	4.0 psf	y
1 in	Exterior Stucco	@	11.4 psf per inch.	0.0 psf	n
1 in	Wood Sheathing	@	3.0 psf per inch	0.0 psf	n
0.5 in	Gypsum Sheathing	@	4.0 psf per inch	0.0 psf	n
0.5 in	Gypsum Wallboard	@	4.4 psf per inch	0.0 psf	n
	Porcelain Enamel Panels	@	5.0 psf	0.0 psf	n
	Metal Lath & Plaster (Gypsum Plaster)	@	10.0 psf	0.0 psf	n
	Wall Insulation	@	1.0 psf	1.0 psf	y
1 in	Insulation (Rigid)	@	1.5 psf per inch	0.0 psf	n
1 in	Insulation Boards (Fiber Board)	@	1.5 psf per inch	0.0 psf	n
0.5 in	Fire Proofing	@	2 psf per inch	0.0 psf	n
	Wall Framing	@	20.0 psf	20.0 psf	y
8 in	Concrete Wall (Normal Weight)	@	12.5 psf per inch	0.0 psf	n
8 in	CMU Wall w/ Full Grouting (Normal Weight)	@	83.0 psf	0.0 psf	n
8 in	Solid CMU Wall (Normal Weight)	@	87.0 psf	0.0 psf	n
4 in	HCB Wall w/ Full Grouting	@	38.0 psf	0.0 psf	n
3.5 in	Solid Clay Brick Wall	@	11.1 psf per inch	0.0 psf	n
0.5 in	Plywood	@	3.2 psf per inch	0.0 psf	n
16 in O.C.	Wood Studs (2 x 4)	@	1.1 plf	0.0 psf	n
16 in O.C.	Metal Channel Studs	@	2.0 plf	0.0 psf	n
8 ft O.C.	Steel Girts	@	6.0 plf	0.0 psf	n
	Miscellaneous	@	1.0 psf	1.0 psf	y
	Other	@	1.0 psf	0.0 psf	n
	Other	@	1.0 psf	0.0 psf	n
	Other	@	1.0 psf	0.0 psf	n
	Other	@	1.0 psf	0.0 psf	n
	Other	@	1.0 psf	0.0 psf	n

Solid Wall Weight = 26.0 psf
 Window & Door Weight = 8.0 psf
 % Solid Wall = 80%
WALL-R WEIGHT = 22.4 psf

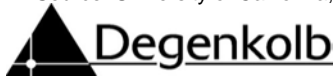

Subject: Seismic Mass	Job Number: B9956006.00	Date: 06/28/19
Job: UCSC Tier 1 Seismic Evaluations - CAAN# 7171 Eastern Addition	By: JSW	Section:
	Checked By:	Page

SEISMIC MASS

ASCE 41-17 SEISMIC EVALUATION & RETROFIT OF EXISTING BUILDINGS
 CHAPTER 4 - TIER 1 EVALUATION
 LINEAR STATIC PROCEDURE
 COLLAPSE PREVENTION
 BSE-2E HAZARD LEVEL

ROOF/FLOOR WEIGHT SUMMARY:

Level Type	Weight [psf]
ROOF	26

WALL WEIGHT SUMMARY:

Wall Type	Weight [psf]		
	Net	Solid	Openings
WALL-P	26.0	26	8
WALL-R	22.4	26	8

SEISMIC MASS SUMMARY:

Level	FLOOR			WALL ABOVE				WALL BELOW				TOTAL WEIGHT [kips]
	Level Type	Weight [psf]	Area [sf]	Wall Type	Weight [psf]	Length [ft]	Height [ft]	Wall Type	Weight [psf]	Length [ft]	Height [ft]	
Roof	ROOF	26	1,688	WALL-P	26.0	0	0.00	WALL-R	22.4	0	7.00	44
											TOTAL	44

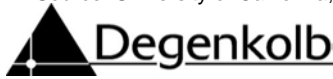

Subject: Seismic Forces	Job Number: B9956006.00	Date: 06/28/19
Job: UCSC Tier 1 Seismic Evaluations - CAAN# 7171 Eastern Addition	By: JSW	Section:
	Checked By:	Page:

SEISMIC FORCES

ASCE 41-17 SEISMIC EVALUATION & RETROFIT OF EXISTING BUILDINGS
 CHAPTER 4 - TIER 1 EVALUATION
 LINEAR STATIC PROCEDURE
 COLLAPSE PREVENTION
 BSE-2E HAZARD LEVEL

BUILDING TYPE: S3 (Metal Building Frames) [ASCE 41-17, Table 3-1]
SITE CLASS: D (default) #N/A [ASCE 41-17, §2.4.1.6]

DESIGN SPECTRAL ACCELERATIONS:

S_{XS} = 1.548 g (BSE-2E) Site-Adjusted Design (T = 0.2 sec) [ASCE 41-17, Eq. 2-1]
 S_{X1} = 0.887 g (BSE-2E) Site-Adjusted Design (T = 1.0 sec) [ASCE 41-17, Eq. 2-2]

BUILDING PERIOD:

h_n = 28.0 ft (Base to Roof) Building Height [ASCE 41-17, §4.4.2.4]
 C_t = 0.020 (Building Type S3) Period Coefficient [ASCE 41-17, §4.4.2.4]
 β = 0.750 (Building Type S3) Period Exponent [ASCE 41-17, §4.4.2.4]
 T = 0.243 sec = $C_t h_n^\beta$ Fundamental Period [ASCE 41-17, Eq. 4-4]

RESPONSE SPECTRUM:

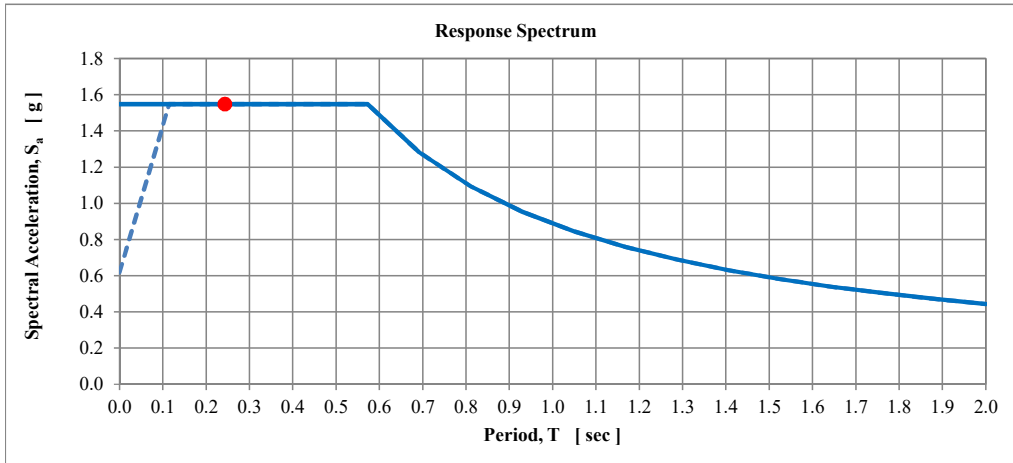

PSEUDO LATERAL FORCE:

n = 1 (n = 1) Total Number of Stories
 C = 1.3 (Building Type S3) Modification Factor [ASCE 41-17, Table 4-7]
 S_a = 1.548 g = MIN { S_{X1} / T , S_{XS} } Spectral Acceleration [ASCE 41-17, Eq. 4-3]
 V = 2.012 W = $C S_a W$ Pseudo Lateral Force [ASCE 41-17, Eq. 4-1]

VERTICAL DISTRIBUTION OF SEISMIC FORCES:

k = 1.00 ($T \leq 0.5$ sec) Seismic Distribution Exponent [ASCE 41-17, §4.4.2.2]

Level	h_x [ft]	w_x [kips]	$w_x h_x^k$	C_{vx}	F_x [kips]	V_j [kips]
Roof	14.0	44	614	1.00	88	88
TOTAL	-	44	614	1.00	88	-

$F_x = C_{vx} V = [w_x h_x^k / \sum (w_x h_x^k)] V$ [ASCE 41-17, Eq. 4-2a]
 $V_j = \sum F_x$ [ASCE 41-17, Eq. 4-2b]



Purpose: Perform compactness and moment capacity checks for an S3 Building

Procedure: The calculation steps are as follows

Step 1: Calculate member compactness requirements

Step 2: Check moment connection for elastic moment of the adjoining member

Step 3: Check tension only bracing capacity in the addition structures

Step 1 - Calculate member compactness requirements

Dimensions based on site visit measurements and scaling in Bluebeam

Do not have web thickness so can not check for web compactness

ASTM A36 grade steel assumed based on date of construction.

$$b := \frac{6.5 \text{ in}}{2} = 3.25 \text{ in}$$

$$f_y := 36 \text{ ksi}$$

$$t_f := 0.25 \text{ in}$$

$$E := 29000 \text{ ksi}$$

$$\frac{b}{t_f} = 13$$

$$0.56 \cdot \sqrt{\frac{E}{f_y}} = 15.89$$

$$\frac{b}{t_f} < 0.56 \cdot \sqrt{\frac{E}{f_y}} = 1$$

Step 2 - Check moment connection for elastic moment of the adjoining member

Dimensions based on site visit measurements and scaling in Bluebeam

$$B := 2 \cdot b$$

$$H := 15.5 \text{ in}$$

$$h := H - 2 \cdot t_f = 15 \text{ in}$$

$$t_w := 0.25 \text{ in} \quad \text{Assumed W14x38 at connection}$$

$$b := B - t_w$$

$$S_x := \frac{B \cdot H^2}{6} - \frac{b \cdot h^3}{6H} = 33.46 \text{ in}^3$$

$$M_u := f_y \cdot S_x = 1204.43 \text{ kip} \cdot \text{in}$$

$$a := 16 \text{ in}$$

$$A_{\text{bolt}} := 0.442$$

$$T_{\text{bolt}} := \frac{M_u}{a \cdot 4 \cdot A_{\text{bolt}}} = 42.58 \text{ kip}$$

$$\phi r_n := 14.9 \cdot \text{kip} \quad \text{Table 7-2}$$

$$DCR_{\text{Connection}} := \frac{T_{\text{bolt}}}{\phi r_n} = 2.86$$

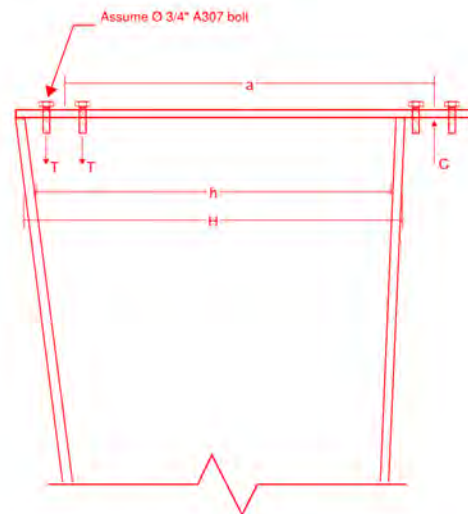



Step 3 - Check tension only bracing capacity in the addition structures

Eastern Addition - East Wall

$$L_{br} := 33 \text{ ft} + 6 \text{ in}$$

$$A_{br} := 0.058 \cdot \text{in}^2$$

$$N_{br} := 1$$

$$s := 22 \text{ ft} + 3 \text{ in}$$

$$V_j := \frac{88 \text{ kip}}{2} = 44 \text{ kip}$$

$$f_{j_avg} := \frac{1}{M_s} \cdot \left(\frac{V_j}{s \cdot N_{br}} \right) \cdot \left(\frac{L_{br}}{A_{br}} \right) = 326.34 \text{ ksi}$$

$$f_{j_avg} < 0.5 \cdot f_y = 0$$

Assumed A416

$$f_{pu} := 250 \text{ ksi}$$

$$f_y := 0.85 \cdot f_{pu} = 212.5 \text{ ksi}$$

$$M_s := 3.5$$

Eastern Addition - West Wall

$$L_{br} := 24 \text{ ft} + 8 \text{ in}$$

$$A_{br} := 0.144 \cdot \text{in}^2$$

$$N_{br} := 1$$

$$s := 20 \text{ ft} + 9 \text{ in}$$

$$f_{j_avg} := \frac{1}{M_s} \cdot \left(\frac{V_j}{s \cdot N_{br}} \right) \cdot \left(\frac{L_{br}}{A_{br}} \right) = 103.78 \text{ ksi}$$

$$f_{j_avg} < 0.5 \cdot f_y = 1$$

Southern Addition - Southern Wall

$$L_{br} := 22 \text{ ft} + 1 \text{ in}$$

$$A_{br} := 0.036 \cdot \text{in}^2$$

$$N_{br} := 1$$

$$s := 19 \text{ ft} + 6 \text{ in}$$

$$V_j := 19 \text{ kip}$$

$$f_{j_avg} := \frac{1}{M_s} \cdot \left(\frac{V_j}{s \cdot N_{br}} \right) \cdot \left(\frac{L_{br}}{A_{br}} \right) = 170.77 \text{ ksi}$$

$$f_{j_avg} < 0.5 \cdot f_y = 0$$



University of California, Santa Cruz
ASCE 41-17 Tier 1 Seismic Evaluation
7171 - Astronomy Lab A

Appendix C
Pictures and Details



University of California, Santa Cruz
ASCE 41-17 Tier 1 Seismic Evaluation
7171 - Astronomy Lab A



South Addition



Portal Frame Moment Connection



University of California, Santa Cruz
ASCE 41-17 Tier 1 Seismic Evaluation
7171 - Astronomy Lab A



Eastern addition interior



Original structure to eastern addition



University of California, Santa Cruz
ASCE 41-17 Tier 1 Seismic Evaluation
7171 - Astronomy Lab A

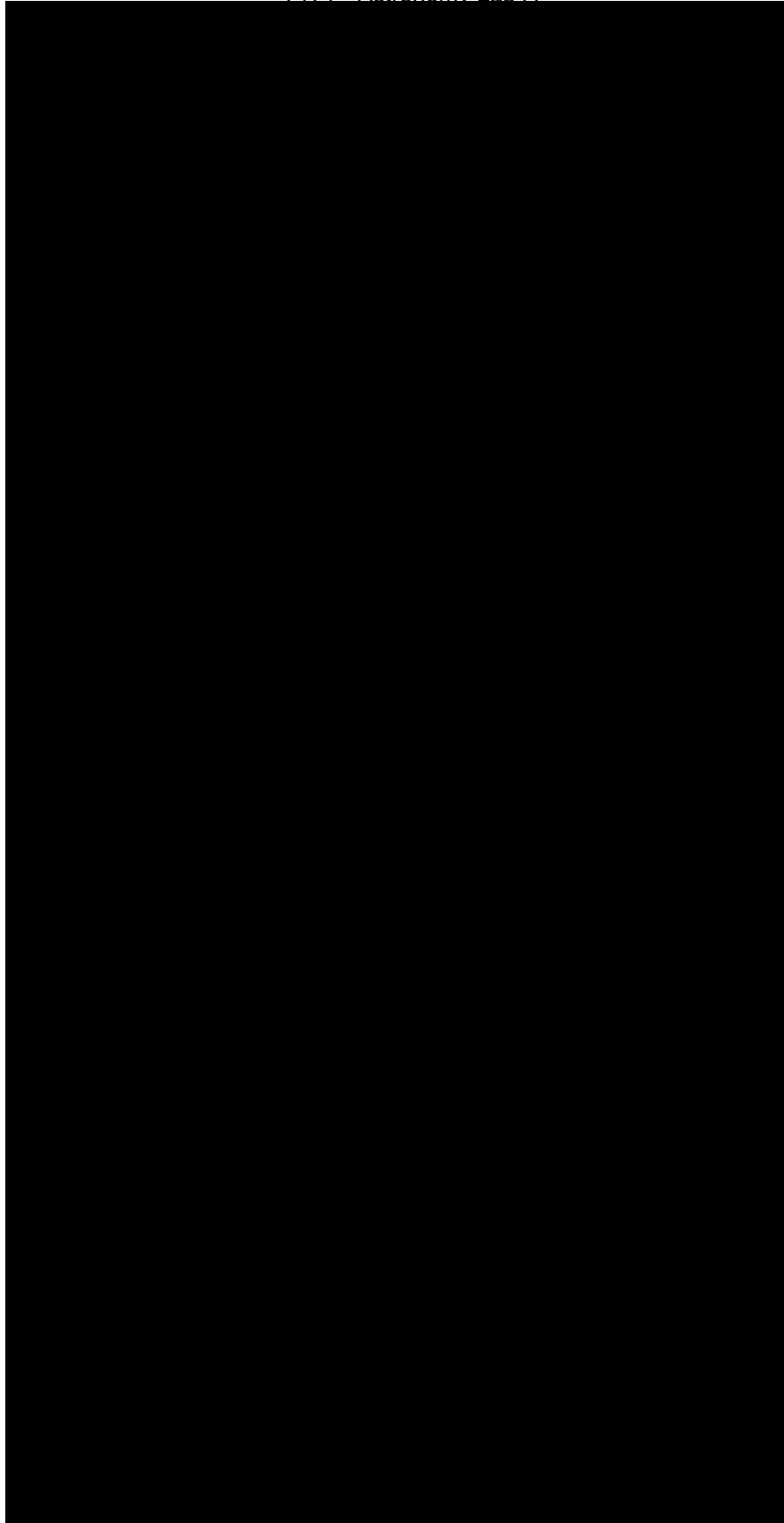

Original structure plan



University of California, Santa Cruz
ASCE 41-17 Tier 1 Seismic Evaluation
7171 - Astronomy Lab A

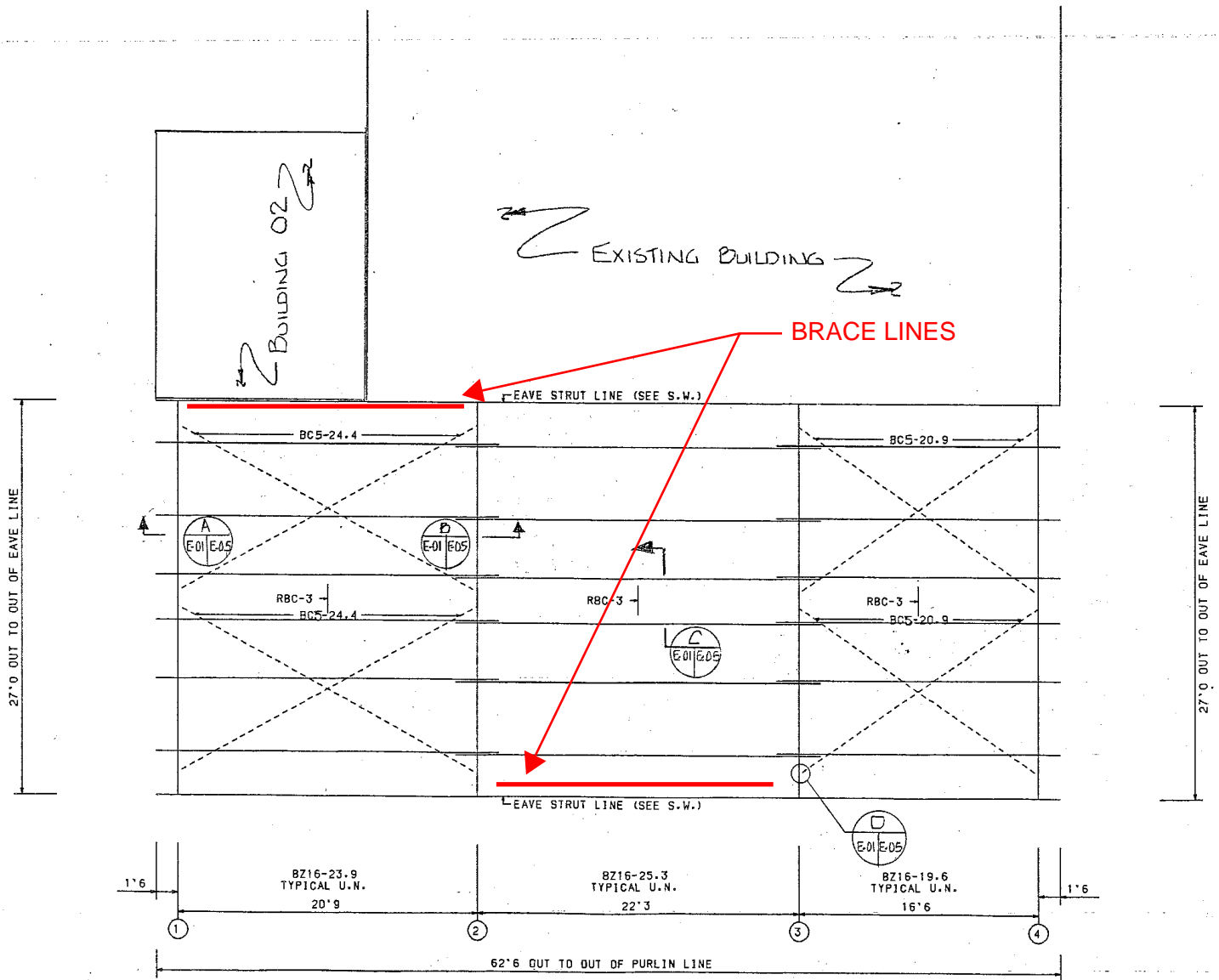

ROOF FRAMING PLAN RFO1F-A

ROOF FRAMING PLAN: ALL ROOF FRAMING MEMBERS ARE 8 INCH ZEE SECTIONS 16 GAGE THICK UNLESS OTHERWISE NOTED.

Eastern addition plan



University of California, Santa Cruz
 ASCE 41-17 Tier 1 Seismic Evaluation
 7171 - Astronomy Lab A

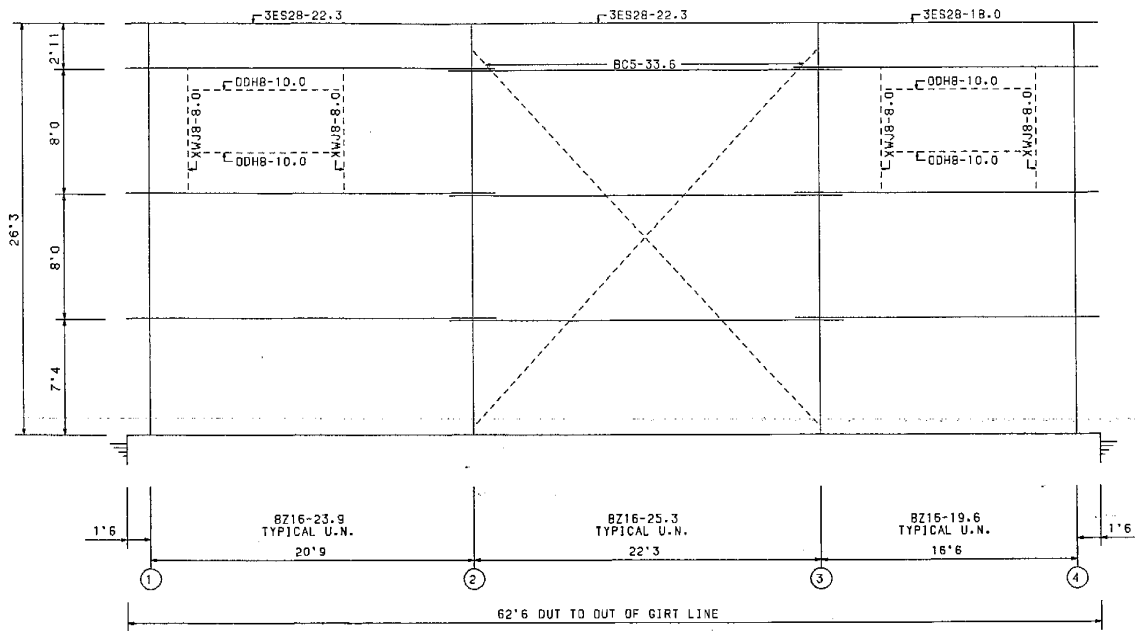

SIDEWALL FRAMING PLAN SW01F-A

SIDEWALL FRAMING PLAN: ALL SIDEWALL FRAMING MEMBERS ARE 6" INCH ZEE SECTIONS 1/2" GA. THICK, UNLESS OTHERWISE NOTED.

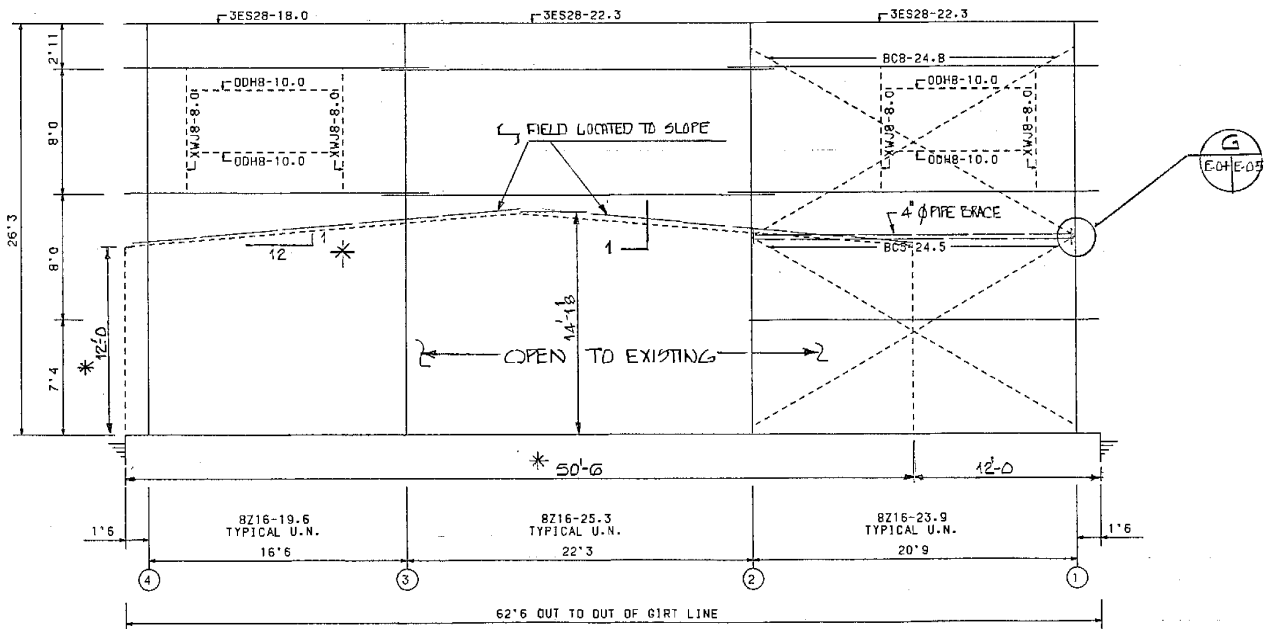

SIDEWALL FRAMING PLAN SW02F-A

SIDEWALL FRAMING PLAN: ALL SIDEWALL FRAMING MEMBERS ARE 6" INCH ZEE SECTIONS 1/2" GA. THICK, UNLESS OTHERWISE NOTED.

- *PLEASE VERIFY:
- 1) EXACT EAVE HEIGHT
 - 2) ROOF SLOPE 1:12
 - 3) 50'-0" WIDTH

Eastern addition elevations



University of California, Santa Cruz
ASCE 41-17 Tier 1 Seismic Evaluation
7171 - Astronomy Lab A

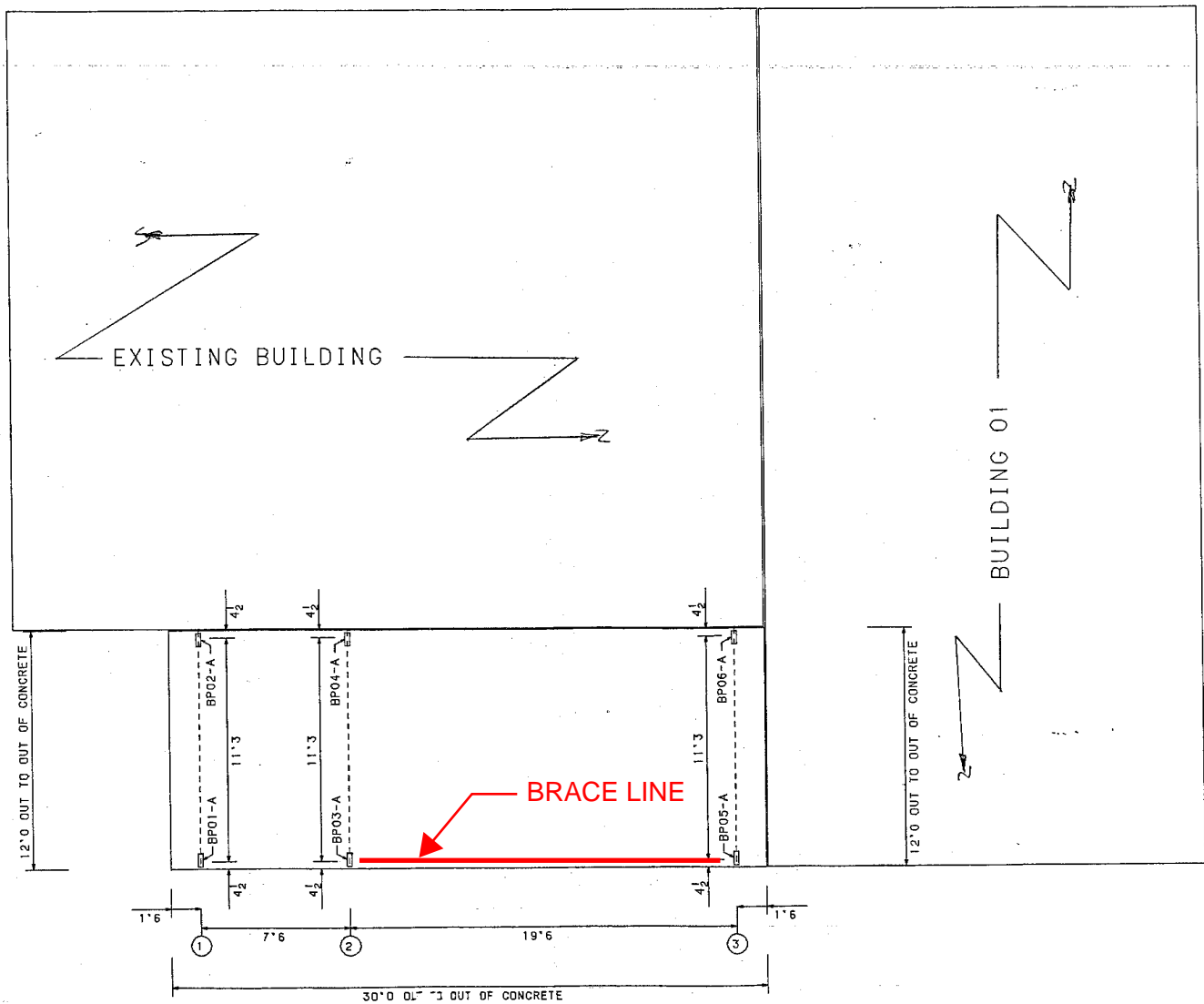

Southern addition plan



University of California, Santa Cruz
ASCE 41-17 Tier 1 Seismic Evaluation
7171 - Astronomy Lab A

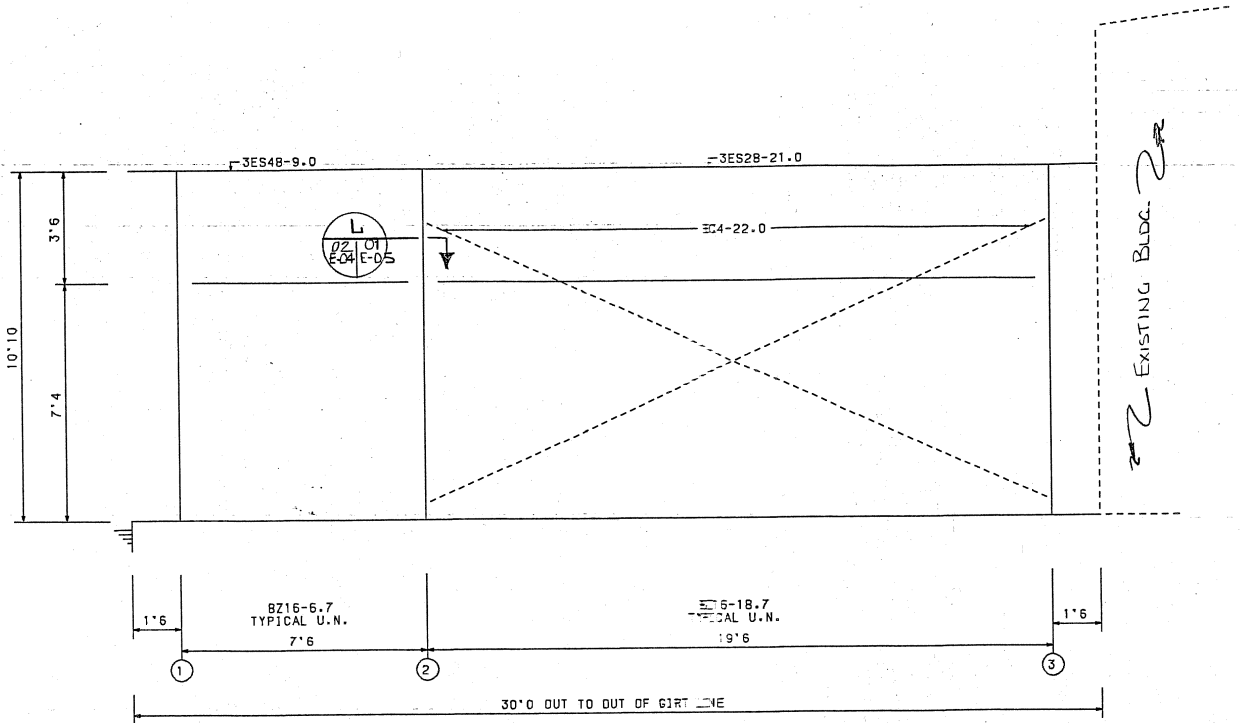

SIDEWALL FRAMING PLAN SW01F-A

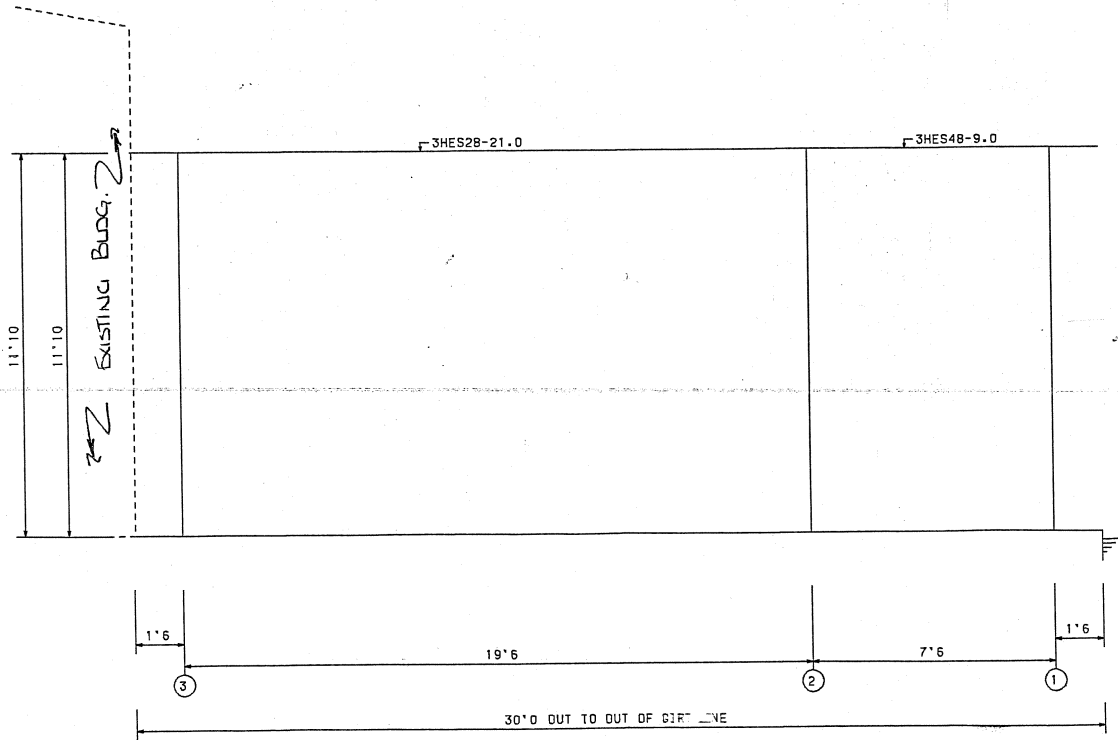

SIDEWALL FRAMING PLAN SW02F-A

Southern addition elevations